

## 3.4 Fuel Cells

Fuel cells efficiently convert diverse fuels directly into electricity without combustion, and they are key elements of a broad portfolio for building a competitive, secure, and sustainable clean energy economy. They offer a broad range of benefits, including reduced greenhouse gas emissions; reduced oil consumption; expanded use of renewable power (through the use of hydrogen derived from renewable resources as a transportation fuel as well as for energy storage and transmission); highly efficient energy conversion; fuel flexibility (use of diverse, domestic fuels, including hydrogen, natural gas, biogas, and methanol); reduced air pollution, criteria pollutants, water use; and highly reliable grid support. Fuel cells also have numerous advantages that make them appealing for end users, including quiet operation, low maintenance needs, and high reliability. Because of their broad applicability and diverse uses, fuel cells can address critical challenges in all energy sectors: commercial, residential, industrial, and transportation.

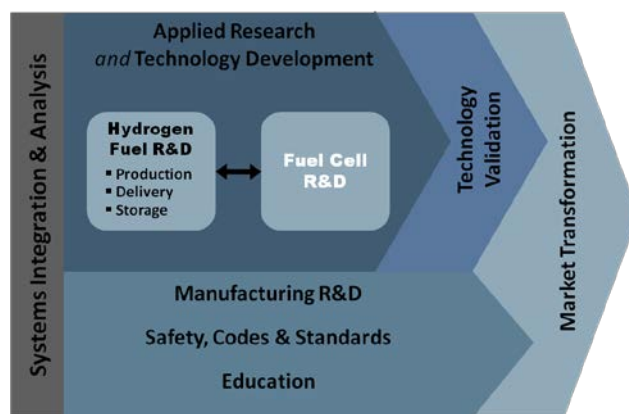

The fuel cell industry had revenues of approximately \$2.2 billion in 2014, an increase of almost \$1 billion over revenues in 2013.<sup>1</sup> The largest markets for fuel cells today are in stationary power, portable power, auxiliary power units, backup power, and material handling equipment. Approximately 155,000 fuel cells were shipped worldwide in the four-year period from 2010 through 2013, accounting for 510–583 MW of fuel cell capacity.<sup>2</sup> In 2014 alone, more than 50,000 fuel cells accounting for over 180 MW of capacity were shipped.<sup>1</sup> In transportation applications, manufacturers have begun to commercialize fuel cell electric vehicles (FCEVs). Hyundai and Toyota have recently introduced their FCEVs in the marketplace, and Honda is set to launch its new FCEV in the market in 2016. Others, including Daimler, reportedly are set to begin commercialization in 2017.<sup>3</sup>

While fuel cells are becoming competitive in a few markets, commercialization can be greatly expanded with improvements in durability, performance, and cost reductions. The Fuel Cells sub-program in the Fuel Cell Technologies Office (the Office) has been addressing key challenges to accelerate market growth. In particular, the Fuel Cells sub-program is pursuing fuel cells as replacements for internal combustion engines in light-duty vehicles to increase vehicle efficiency and support the goals of reducing oil use in and emissions from the transportation sector.

The Office also supports fuel cells for stationary power applications (primary and backup) due to their high efficiency and the potential to reduce primary energy use for and emissions from electricity production. In addition, the Office supports fuel cells for early markets such as material handling equipment, specialty vehicles, and auxiliary power applications. Growth in early markets can help to reduce costs industry-wide by driving manufacturing volume. Growth in these markets can also help develop infrastructure, strengthen consumer acceptance, and address a variety of other logistical challenges. The technical focus is on developing materials, components, and subsystems at the stack and system level that enable fuel cell technology to achieve the Office's objectives, primarily related to system cost and durability. The Fuel Cells sub-program's research and development (R&D) portfolio is primarily focused on polymer electrolyte membrane fuel cells (PEMFCs), but it also includes work on longer term technologies such as alkaline membrane fuel cells (AMFCs) and

<sup>1</sup> DOE Fuel Cell Technologies Office, *2014 Fuel Cells Technology Market Report* (Washington, D.C. 2015), [http://energy.gov/sites/prod/files/2015/10/f27/fcto\\_2014\\_market\\_report.pdf](http://energy.gov/sites/prod/files/2015/10/f27/fcto_2014_market_report.pdf).

<sup>2</sup> E4Tech, *The Fuel Cell Industry in Review 2015* (London, U.K.: 2015), [www.FuelCellIndustryReview.com](http://www.FuelCellIndustryReview.com).

<sup>3</sup> Daimler, AG, *Ready to Start Up* (Stuttgart, Germany: 2015), <https://www.daimler.com/documents/company/other/daimler-corporateprofile-en-2015.pdf>.

higher temperature fuel cells such as molten carbonate fuel cells (MCFCs) for stationary applications. The development of high-temperature solid oxide fuel cells (SOFCs) operating on coal or natural gas is in the purview of the Office of Fossil Energy (FE), with the Office (Fuel Cell Technologies Office) Fuel Cells sub-program supporting application-driven efforts such as utilization of FE-developed technologies for small-scale combined heat and power (CHP) applications. For transportation applications, the Office's effort is focused on direct hydrogen fuel cells, in which the hydrogen fuel is stored onboard and supplied by a hydrogen production and fueling infrastructure. Hydrogen production and delivery technologies are being developed in parallel with fuel cell development efforts. For distributed stationary power generation applications, fuel cell systems will likely be fueled with reformat produced from natural gas, liquefied petroleum gas (LPG, consisting predominantly of propane), associated petroleum gas (APG), or renewable fuels such as biogas derived from wastewater treatment plants and landfill gas. In material handling equipment and portable power applications, hydrogen and liquid biofuels such as methanol will be the fuel of choice for these fuel cell systems, respectively. Fuel cells for auxiliary power units (APUs) in trucks will mainly use either (bio-) diesel or LPG.

### 3.4.1 Technical Goal and Objectives

#### Goal

Advance fuel cell technologies for transportation, stationary, and early market applications.

#### Objectives

- Develop a 65% peak-efficient, direct hydrogen fuel cell power system for transportation that can achieve 5,000-hour durability (ultimate 8,000 hours) and be mass produced at a cost of \$40/kW by 2020 (ultimate \$30/kW).
- Develop distributed generation and micro-CHP fuel cell systems (5 kW) operating on natural gas that achieve 45% electrical efficiency and 60,000-hour durability at an equipment cost of \$1,500/kW by 2020.
- Develop medium-scale CHP systems (100 kW–3 MW) by 2020 that achieve 50% electrical efficiency, 90% CHP efficiency and 80,000-hour durability at a cost of \$1,500/kW for operation on natural gas and \$2,100/kW when configured for operation on biogas.

### 3.4.2 Technical Approach

The Fuel Cells sub-program focuses on R&D to address challenges facing fuel cells for automotive applications with potential spillover benefits for near-term applications such as distributed power (primary and backup), material handling equipment, specialty vehicles, and APUs, which will help drive manufacturing volume. These near-term applications will generate market traction for the adoption of longer term applications such as light-duty vehicles, which have the greatest potential impact for fuel cell technologies on national energy goals and associated metrics, as well as other transportation systems such as APUs that could be applicable for truck, marine, or aircraft applications, and they would also provide substantial environmental and energy-security benefits.

Fuel cell R&D emphasizes activities aimed at achieving high efficiency and durability along with low material and manufacturing costs for the fuel cell stack. R&D activities include developing lower cost, better performing system balance of plant (BOP) components such as air compressors, fuel processors, sensors, and water and heat management systems. The sub-program also supports the development of experimental diagnostics and theoretical models to gain a foundational understanding of reaction mechanisms and to optimize material structures and technology configurations. Each application—light-duty vehicle and bus transportation, stationary power, material handling equipment, specialty vehicles, APUs for heavy-duty

vehicles, and portable power for consumer electronics—has specific market-driven requirements for technology development.

PEMFCs (Figure 3.4.1) are being considered for applications that require faster start-up times and frequent starts and stops, such as automotive applications, material handling equipment, and backup power. For PEMFCs, continuing advancements are needed to minimize or eliminate precious metal loading, improve component durability, and manage water transport within the cell. Additionally, membranes that are capable of operation at higher temperatures (up to 120°C for automotive applications and above 120°C for stationary applications) are needed for better thermal management. R&D is required to reduce cost and increase durability of the membrane electrode assembly (MEA) as well as optimize the integration of advanced cell components into the MEA. R&D is also required to reduce the cost and improve the durability of system BOP components, such as humidifiers and compressors.

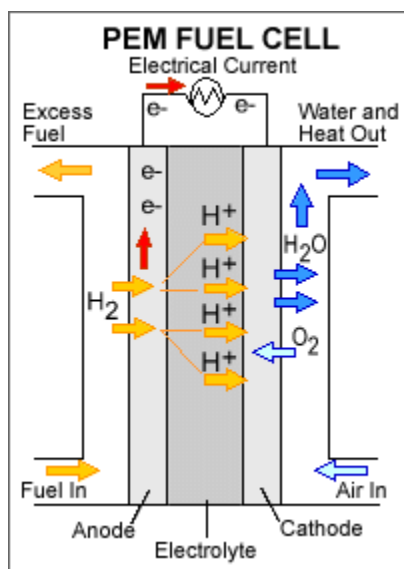

Figure 3.4.1 Polymer electrolyte membrane fuel cell (PEMFC) schematic.

Direct methanol fuel cells (DMFCs) are well suited for early market applications as sources of portable and backup power in consumer electronic devices and similar applications where the power requirements are low and the cost targets and infrastructure requirements are not as stringent as for transportation applications. A higher energy density alternative to existing technologies is required to fill the increasing gap between energy demand and energy storage capacity in these low power applications. Challenges for DMFCs include reducing Pt loading, reducing methanol crossover to increase efficiency, and simplifying the BOP to increase energy and power density, improve reliability, and reduce cost.

Alkaline fuel cells (AFCs) (Figure 3.4.2) were one of the first fuel cell technologies developed, and they were the first type widely used in the U.S. space program to produce electricity and water onboard spacecraft. One advantage of AFCs is that they can use a variety of nonprecious metal catalysts at the anode and cathode. The initial AFCs used aqueous potassium hydroxide (KOH) solutions as the electrolyte. To address some of the issues dealing with these liquid electrolytes, novel AFCs that use a polymer membrane as the electrolyte have been developed. These fuel cells are closely related to conventional PEMFCs except that they use an alkaline membrane instead of an acid membrane, and they are commonly referred to as AMFCs. Challenges for AMFCs include tolerance to carbon dioxide, membrane conductivity and durability, higher temperature operation, water management, power density, and anode electrocatalysis.

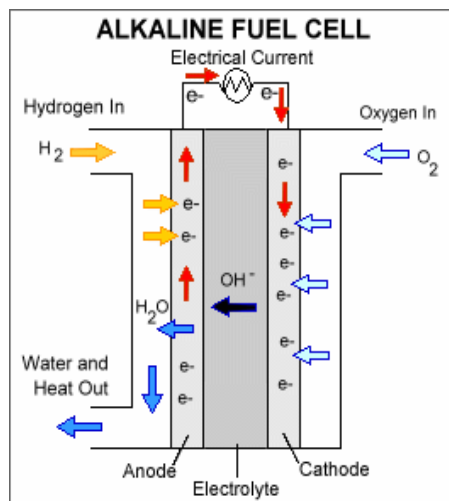

Figure 3.4.2 Alkaline fuel cell (AFC) schematic.

Medium-temperature (phosphoric acid) (Figure 3.4.3a) and high-temperature (solid oxide and molten carbonate) (Figure 3.4.3b and 3.4.3c, respectively) fuel cells are more applicable for systems that run for extended periods of time without frequent start and stop cycles. These systems also have benefits for CHP generation, and they offer simplified operation on fossil and renewable fuels. The high-temperature systems can also be utilized in tri-generation mode to produce electrical power, heat, and hydrogen. R&D needs for phosphoric acid-based fuel cells (PAFCs) include methods to decrease or eliminate anion adsorption on the cathode, lower cost materials for the cell stack and BOP components, and durable electrode catalyst and support materials. Polymer-phosphoric acid-based systems including polybenzimidazole-phosphoric acid type (PBI-type) have applications similar to PAFC. For high-temperature MCFCs, R&D is needed to limit electrolyte loss and prevent microstructural changes in the electrolyte support that lead to early stack failure. R&D is also needed to develop more robust cathode materials. For SOFCs, challenges include stack survivability during repeated thermal cycling, decreasing long start-up times, and potential mechanical and chemical compatibility/reactivity issues between the various stack and cell components due to high-temperature operation. For all of these systems, improved fuel processing and cleanup, especially for fuel-flexible operation and operation on biofuels, are needed to improve durability and reduce system costs. Table 3.4.1 describes the different fuel cell types discussed here.

To meet the efficiency, durability, and cost requirements for fuel cells, R&D will focus on identifying new materials and novel design and manufacturing methods for electrolytes and electrolyte supports, catalysts and supports, gas diffusion media, cell hardware (including bipolar plates and seals), and BOP components (e.g., compressors, radiators, humidifiers, fuel processors, etc.). Testing of new materials, designs, and fabrication methods will be carried out by industry, national laboratories, and universities. New R&D efforts will include demonstrations in single cells or membrane electrolyte assemblies (MEAs), in stacks, and at the subsystem and system level. The Technology Validation sub-program section provides fuel cell vehicle and stationary power data under real-world conditions and, in turn, supplies valuable results to help refine and direct future activities for fuel cell R&D.

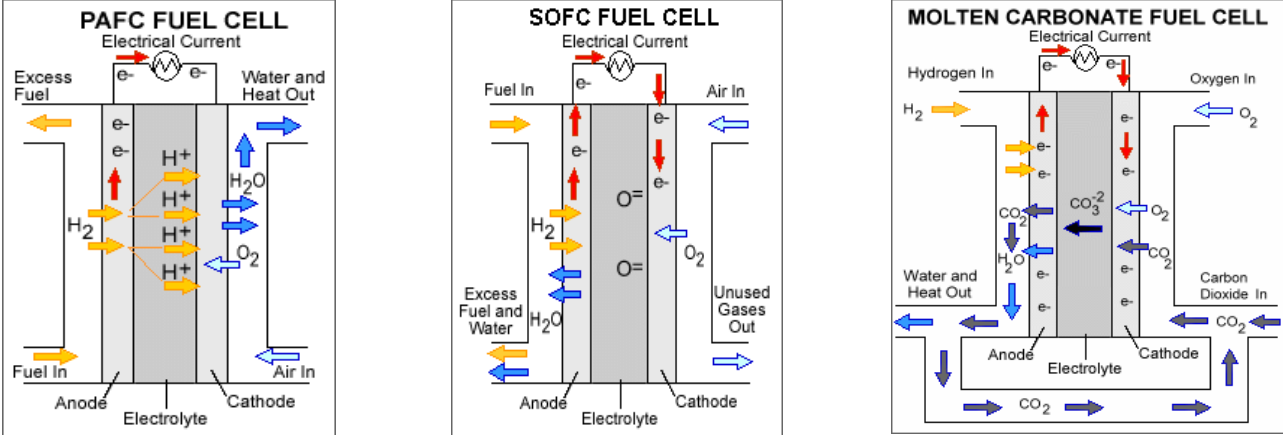

Figure 3.4.3 Schematics of (a) phosphoric acid-based fuel cells (PAFCs), (b) solid oxide fuel cells (SOFCs), and (c) molten carbonate fuel cells (MCFCs).

Table 3.4.1 Fuel Cell Types		
Fuel Cell Type	Temperature	Applications
	Common Electrolyte/ Charge Carrier	
Polymer Electrolyte Membrane (PEMFC)	<120°C	Backup power, Portable power, Distributed generation, Transportation, Specialty vehicles
	Perfluorosulfonic acid / H <sup>+</sup>	
Direct Methanol (DMFC)	<100°C	Early market applications
	Perfluorosulfonic acid / H <sup>+</sup>	
Alkaline (AFC), Alkaline Membrane Fuel Cell (AMFC)	<100°C	Military, Space, Backup power, Transportation
	aqueous KOH, alkaline polymer / OH <sup>-</sup>	

Table 3.4.1 Fuel Cell Types		
Fuel Cell Type	Temperature	Applications
	Common Electrolyte/ Charge Carrier	
Phosphoric Acid (PAFC) and Polymer Phosphoric Acid	150–200°C	Distributed generation
	H <sub>3</sub> PO <sub>4</sub> , Polymer/H <sub>3</sub> PO <sub>4</sub> , H <sup>+</sup>	
Molten Carbonate (MCFC)	600–700°C	Electric utility, Distributed generation
	(Li,K,Na) <sub>2</sub> CO <sub>3</sub> / CO <sub>3</sub> <sup>2-</sup>	
Solid Oxide (SOFC)	500–1,000°C	Electric utility, Distributed generation, APUs
	Ytria–Stabilized Zirconia (Zr <sub>0.92</sub> Y <sub>0.08</sub> O <sub>2</sub> ) / O <sup>2-</sup>	

### 3.4.3 Programmatic Status

#### Current Activities

Table 3.4.2 summarizes the FY 2016 Fuel Cells sub-program activities. Catalysts are a major cost driver and a current focus area. Catalysts with reduced platinum group metal (PGM) loading or no PGMs, increased activity and durability, and lower cost are under development. Catalyst supports with increased durability and conductivity are being evaluated to address a key degradation mode of fuel cells. Ionomers and membranes are being identified and developed with increased conductivity (especially under conditions of low relative humidity and high temperature), increased mechanical and chemical durability, and reduced material costs. Electrode and MEA design (integration of the catalysts, support, membrane, and GDLs) are being pursued because they can have a large impact on overall performance, especially under high power conditions. Bipolar plates with lower weight, lower volume, and higher corrosion resistance are being developed. Scalable manufacturing processes for the production of catalysts, membranes, electrodes, MEAs, and bipolar plates are being designed. Failure mechanisms in fuel cells are being explored both experimentally and via modeling, including measuring the effects of impurities on fuel cell performance and durability. To enable early-market entry of fuel cells, the sub-program supports R&D pertaining to stationary, backup, and auxiliary power units. To gauge the status of the technology, the cost and performance of fuel cell components are benchmarked and evaluated annually.

In an effort to further accelerate the development of the critical materials needed to realize widespread deployment of hydrogen and fuel cell technologies, the sub-program launched and planned several national laboratory-based consortia. The purpose of the consortium structure is to coordinate the powerful and unique capabilities found across the U.S. national laboratory system to make it easier for external research partners to rapidly connect and take advantage of these resources. In 2015, the Fuel Cells sub-program launched a lab-led consortium project on Fuel Cell Performance and Durability (FC-PAD)<sup>4</sup> to further advance progress in

<sup>4</sup> “Fuel Cell Consortium for Performance and Durability (FC-PAD),” <http://energy.gov/eere/fuelcells/fc-pad-fuel-cell-consortium-performance-and-durability>.

improving performance and durability of fuel cell systems. Funding opportunities for adding industry, university, and other national lab projects to FC-PAD are currently underway. Additionally, to address the need for PGM-free catalysts and electrodes, the Fuel Cells sub-program also recently launched the ElectroCat (Electrocatalysis) Consortium<sup>5</sup> under the DOE's Energy Materials Network,<sup>6</sup> an extension of the Materials Genome Initiative.<sup>7</sup> A schematic of the FC-PAD consortium structure is shown in Figure 3.4.4.

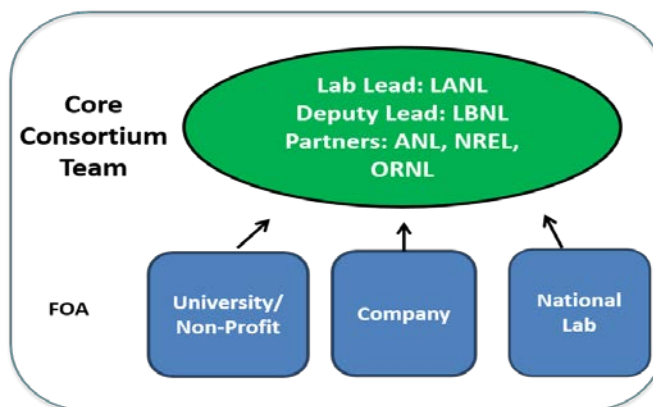

Figure 3.4.4 Organizational structure of the Fuel Cell Performance and Durability (FC-PAD) consortium, created in 2015 to accelerate advances in fuel cell performance and durability.

Table 3.4.2 Current (2016) Fuel Cell Activities		
Task	Approach	Activities
Catalysts/ Electrodes	<ul style="list-style-type: none"> <li>Develop electrocatalysts and electrodes with reduced PGM loading, increased activity, improved durability / stability, and increased tolerance to air, fuel, and system-derived impurities</li> <li>Optimize electrode design and assembly</li> <li>Develop PGM-free anode catalysts for AMFCs and PGM-free cathode catalysts for PEMFCs and AMFCs</li> </ul>	<ul style="list-style-type: none"> <li>3M: Highly Active, Durable, and Ultra-low PGM NSTF Thin Film ORR Catalysts and Supports</li> <li>Argonne National Laboratory: Tailored High Performance Low-PGM Cathode Catalysts</li> <li>Brookhaven National Laboratory: Platinum Monolayer Electrocatalysts</li> <li>General Motors: Highly-Accessible Catalysts for Durable High-Power Performance</li> <li>Illinois Institute of Technology: Corrosion-Resistant Non-Carbon Electrocatalyst Supports for PEMFCs</li> <li>National Renewable Energy Laboratory: Extended Surface Electrocatalyst Development</li> <li>Northeastern University: Innovative Non PGM Catalysts for CHP Relevant Proton Exchange Membrane Fuel Cells</li> </ul>

<sup>5</sup> "Electrocatalysis Consortium (ElectroCat)," <http://www.electrocat.org>.

<sup>6</sup> "Energy Materials Network (EMN)," <http://energy.gov/cere/energy-materials-network/energy-materials-network>.

<sup>7</sup> "Materials Genome Initiative (MGI)," <https://www.whitehouse.gov/mgi>.



Table 3.4.2 Current (2016) Fuel Cell Activities

Task	Approach	Activities
		<ul style="list-style-type: none"> <li>University of New Mexico: Development of non-PGM Catalysts for Hydrogen Oxidation Reaction in Alkaline Media</li> <li>ElectroCat (Electrocatalysis Consortium): Argonne National Laboratory, Los Alamos National Laboratory, National Renewable Energy Laboratory, Oak Ridge National Laboratory</li> </ul>
Membranes/ Electrolytes	<ul style="list-style-type: none"> <li>Develop / identify electrolytes and membranes/matrices (for low and high-temperature proton exchange, alkaline membrane, molten carbonate) with improved conductivity over the entire temperature and humidity range of a fuel cell and increased mechanical, chemical, and thermal stability, with reduced/eliminated fuel cross-over</li> <li>Fabricate membranes from ionomers with scalable fabrication processes, increased mechanical, chemical, and thermal stability, and reduced cost</li> <li>Perform membrane testing and characterization to improve durability</li> </ul>	<ul style="list-style-type: none"> <li>3M: New Fuel Cell Membranes with Improved Durability and Performance</li> <li>Colorado School of Mines: Advanced Hybrid Membranes for Next Generation PEMFC Automotive Applications</li> <li>FuelCell Energy: 'Smart' Matrix Development for Direct Carbonate Fuel Cells</li> <li>Los Alamos National Laboratory: Advanced Materials for Fully-Integrated MEAs in AEMFCs</li> <li>National Renewable Energy Laboratory: Advanced Ionomers and MEAs for Alkaline Exchange Membrane Fuel Cells</li> <li>University of Delaware: Highly Stable Anion-Exchange Membranes for High-Voltage Redox-Flow Batteries</li> </ul>
Membrane Electrode Assemblies, Cells, and Other Stack Components	<ul style="list-style-type: none"> <li>Integrate membranes, electrolytes and electrodes</li> <li>Expand MEA operating range, addressing temperature and humidity range, improving stability, and mitigating effects of impurities</li> <li>Test, analyze, and characterize MEAs</li> <li>Improve gas diffusion layer/microporous layer (GDL/MPL) performance and durability</li> <li>Decrease cost of bipolar plates</li> <li>Improve performance and durability of bipolar plates</li> <li>Integrate low-temp (&lt;600°C) SOFC electrolyte and electrodes into a single cell</li> </ul>	<ul style="list-style-type: none"> <li>3M: High Performance, Durable, Low Cost Membrane Electrode Assemblies for Transportation Applications</li> <li>Advent Technologies: Facilitated Direct Liquid Fuel Cells with High Temperature Membrane Electrode Assemblies</li> <li>Giner: Advanced Catalysts and MEAs for Reversible Alkaline Membrane Fuel Cells,</li> <li>Giner: Ionomer Dispersion Impact on Advanced Fuel Cell and Electrolyzer Performance and Durability, Small Business Innovation Research (SBIR) project</li> <li>Redox Fuel Cells: Affordable, High Performance, Lower Temperature SOFCs</li> </ul>
Fuel Cell Performance and Durability	<ul style="list-style-type: none"> <li>Improve component stability and durability</li> <li>Improve cell performance with optimized transport</li> <li>Develop new diagnostics, characterization tools, and models</li> </ul>	<ul style="list-style-type: none"> <li>Fuel Cell Performance and Durability Consortium (FC-PAD): Los Alamos National Laboratory, Lawrence Berkeley National Laboratory, Argonne National Laboratory, National Renewable Energy Laboratory, Oak Ridge National Laboratory</li> </ul>



Table 3.4.2 Current (2016) Fuel Cell Activities		
Task	Approach	Activities
BOP Components	<ul style="list-style-type: none"> <li>Develop air management technologies for motive and stationary applications</li> <li>Develop humidifiers</li> </ul>	<ul style="list-style-type: none"> <li>Eaton: Roots Air Management System with Integrated Expander</li> <li>Tetramer: New High Performance Water Vapor Membranes to Improve Fuel Cell Balance of Plant Efficiency and Lower Costs, SBIR project</li> </ul>
Fuel Cell Systems	<ul style="list-style-type: none"> <li>Develop stationary fuel cell systems for use in distributed generation</li> <li>Develop auxiliary power units</li> <li>Develop fuel cell technologies for early market applications</li> <li>Develop low cost fuel processors for stationary systems</li> </ul>	<ul style="list-style-type: none"> <li>No current activities</li> </ul>
Testing and Technical Assessment	<ul style="list-style-type: none"> <li>Perform cost analysis</li> <li>Annually update technology status and cost</li> <li>Conduct trade-off analysis</li> <li>Experimentally determine long-term stack failure mechanisms</li> <li>Perform independent testing to characterize component and stack properties</li> </ul>	<ul style="list-style-type: none"> <li>Argonne National Laboratory: Fuel Cells Systems Analysis</li> <li>Strategic Analysis: Manufacturing Cost Analysis of Fuel Cell Systems</li> <li>Oak Ridge National Laboratory: Characterization of Fuel Cell Materials</li> <li>National Institute of Standards and Technology: Neutron Imaging Study of the Water Transport in Operating Fuel Cells</li> <li>Battelle: Stationary and Emerging Market Fuel Cell System Cost Analysis</li> <li>Lawrence Berkeley National Laboratory: A Total Cost of Ownership Model for Design and Manufacturing Optimization of Fuel Cells in Stationary and Emerging Market Applications</li> <li>National Renewable Energy Laboratory: Fuel Cell Technology Status Analysis</li> </ul>

### 3.4.4 Technical Challenges

Cost and durability are the major challenges to fuel cell commercialization. In order to displace established technologies in the marketplace, fuel cells must provide advantages over the incumbent technology (such as increased efficiency and lower emissions) at similar cost and durability. The efficiency and environmental advantages for fuel cells have been demonstrated, but it is still a challenge meeting the cost and durability of incumbent technologies. Fuel cell cost and durability status and challenges for several applications are discussed below:

#### Transportation Systems

##### *Light-Duty Vehicles*

As shown in Figure 3.4.5, durability and cost are the primary challenges to fuel cell commercialization in light-duty vehicle transportation applications. The cost of fuel cell stacks and systems must be reduced before they can be competitive with conventional vehicle technologies (gasoline internal combustion engines). The DOE

system cost target for 2020 is \$40/kW, which is believed to be the point where fuel cell vehicles would be competitive on a life-cycle cost basis with incumbent and future competing technologies. Long-term competitiveness with alternative powertrains, including future advanced gasoline engines, is expected to require further cost reduction to \$30/kW, which represents the sub-program's ultimate cost target.

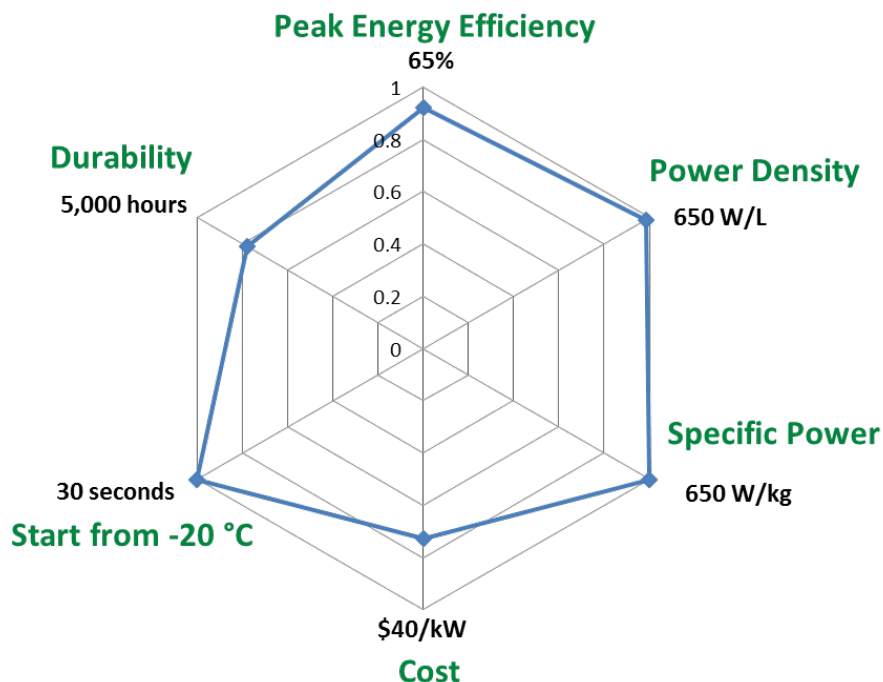

Figure 3.4.5. Fuel cell power system 2020 targets versus 2015 status (blue) for light-duty vehicle applications. (The status is indicated as a fraction of the targets.) Cost status is for a modeled system when manufactured at a volume of 500,000 units/year.

Current modeled cost estimates (2015) place the cost of an 80-kW<sub>net</sub> automotive polymer electrolyte membrane (PEM) fuel cell system based on next-generation laboratory technology and operating on direct hydrogen to be \$53/kW when manufactured at a volume of 500,000 units/year and \$60/kW at a volume of 100,000 units/year. A significant fraction of the cost of a PEM fuel cell comes from the PGM catalysts that are currently used on the anode and cathode for the electrochemical reactions. Other key cost factors include the membrane, cell hardware, and BOP components. It should be noted that the projected cost status is based on an analysis of state-of-the-art components that have been developed and demonstrated through the Fuel Cells sub-program at the laboratory scale. Additional efforts would be needed for the integration of components into a complete automotive system that meets durability requirements in real-world conditions. The expected cost of automotive PEM fuel cell systems based on current technology, planned for commercialization in the 2016 time frame, is approximately \$280/kW when manufactured at a volume of 20,000 units/year.<sup>8</sup>

Fuel cell power systems must be as durable and reliable as current automotive engines. The DOE targets a durability of 5,000 hours (equivalent to approximately 150,000 miles of driving) with less than 10% loss of performance. Ultimately, the DOE targets 8,000 hours of durability to allow 150,000 miles of driving on a lower average-speed drive cycle. This target would address an even larger percentile of drivers. Also, fuel cell

<sup>8</sup> DOE Hydrogen and Fuel Cells Program Record, 15015: Fuel Cell System Cost—2015, September 30, 2015, [https://www.hydrogen.energy.gov/pdfs/15015\\_fuel\\_cell\\_system\\_cost\\_2015.pdf](https://www.hydrogen.energy.gov/pdfs/15015_fuel_cell_system_cost_2015.pdf).

power systems should be able to function over a broad range of external environmental conditions (-40° to +40°C) as well as respond to the rapid variations in power demand required in automotive applications. Results from the Technology Validation sub-program's Learning Demonstration indicated a projected durability of 3,900 hours (2015) before 10% degradation for the automotive fuel cell systems evaluated.<sup>9</sup> Key contributors to fuel cell degradation include loss of catalytic surface area and membrane deterioration. The durability of catalysts can be compromised by platinum sintering and dissolution, especially under conditions of load-cycling and high electrode potentials. Carbon support corrosion is another challenge at high electrode potentials and can worsen under load cycling and high-temperature operation. Membrane durability is affected by both humidity variations, which cause mechanical stresses from swelling and shrinking, and chemical degradation, which can be accelerated by degradation products from the bipolar plates and other components in the fuel cell system. Understanding of the effects of air, fuel, and system-derived impurities (including those from the fuel storage system) needs to be improved, and mitigation strategies need to be identified and demonstrated.

Fuel cell and stack hardware (bipolar plates, gas diffusion layers, and seals) also need further development. Bipolar plates in particular represent a significant fraction of the stack cost, and they must be a focus of cost reduction efforts. Seal materials must be durable over the lifetime of a fuel cell and yield acceptable leak rates.

Cost, efficiency, and packaging of fuel cell BOP components for air, thermal, and water management are also barriers to the commercialization of fuel cells in transportation applications. Air management for fuel cell systems is a challenge because today's compressor technologies are not optimized for automotive fuel cell applications. In addition, thermal and water management for fuel cells are issues. Fuel cell operation at lower temperatures creates a small differential between the operating and ambient temperatures necessitating large heat exchangers and humidifiers. These components increase the cost and complexity of the system and use some of the power that is produced, reducing overall system efficiency.

### *Buses and Heavy-Duty Vehicles*

Transit bus applications represent a promising mid-term market for fuel cell technology. Central fueling of transit bus fleets facilitates the introduction of hydrogen fuel in the transportation market, and the less stringent cost, weight, and volume criteria of heavier vehicles make the implementation of fuel cell propulsion systems less challenging in transit buses than in other transportation applications. However, cost and durability are still challenges for fuel cells in bus applications.

PEMFC technology is the primary fuel cell type considered in fuel cell- or battery-dominant hybrid systems operating on hydrogen. Fuel cell bus development and demonstration activities have been primarily funded by the U.S. Department of Transportation's Federal Transit Administration. While not focusing directly on bus applications, the Office continues to fund research on fuel cell materials that are relevant to bus applications.

Fuel cell bus power plants are offered with a 12,000-hour or 5-year warranty, including air, fuel, and water management systems. A recent fuel cell bus demonstration has surpassed 20,000 operating hours in real-world service with the original cell stacks and no cell replacement.<sup>10</sup> Remaining fuel cell durability issues are difficult to identify and understand through field data. The development and implementation of accelerated stress tests (ASTs) are needed to shorten the time required to address durability issues for all drive cycles and hybridization strategies. Because BOP components, power electronics, and power plant integration issues cause more forced shutdowns than the fuel cell system does, the development of fuel cell-powered buses

---

<sup>9</sup> Jennifer Kurtz et al., "Fuel Cell Electric Vehicle Evaluation," Slide 8 (presented at the DOE Hydrogen and Fuel Cells Program and Vehicle Technologies Office Annual Merit Review, Washington, D.C., June 10, 2015), [http://www.hydrogen.energy.gov/pdfs/review15/tv001\\_kurtz\\_2015\\_o.pdf](http://www.hydrogen.energy.gov/pdfs/review15/tv001_kurtz_2015_o.pdf).

<sup>10</sup> L. Eudy, M. Post, and C. Gikakis, *Fuel Cell Buses in U.S. Transit Fleets: Current Status 2015* (Technical Report NREL/TP-5400-64974) (Golden, CO: National Renewable Energy Laboratory, 2015), <http://www.nrel.gov/docs/fy16osti/64974.pdf>.

should be done at the overall system level. Of course, the hybridization strategy chosen has a major effect on system design and technical requirements.

Although fuel cell durability increases have been realized and costs have been reduced for bus applications, the efficiency, durability, and cost targets (manufacturing, capital, operations, and maintenance) for fuel cells have not yet been met. Initial capital cost is a particularly important target.

Medium- and heavy-duty trucks are an emerging application for fuel cells. Medium- and heavy-duty vehicles accounted for 6 quads of petroleum use in 2012.<sup>11</sup> Emissions from these vehicles are also a concern because they were the source of over 400 MMT of CO<sub>2</sub> emissions in 2012, and diesel-powered vehicles and equipment account for nearly half of NO<sub>x</sub> and more than two-thirds of all particulate matter emissions from U.S. transportation sources.<sup>7,12</sup> Fuel cells offer the opportunity for reduced emissions and petroleum usage while increasing efficiency in this sector. Central fueling of fleets for some heavy- and medium-duty trucks facilitates the introduction of hydrogen fuel in this market, especially if fleets are colocated with material handling equipment utilizing hydrogen. However, fuel cells still need to be demonstrated in these applications. See the Market Transformation section for information on the application of fuel cells in medium- and heavy-duty trucks. Truck technical targets are currently under development.

### Stationary Power Systems

The stationary fuel cell market accounts for the majority of the current global fuel cell market in terms of megawatts shipped.<sup>13</sup> Stationary fuel cells can be used in a broad range of commercial, industrial, and residential applications, from multi-megawatt systems for large centralized power generation to small units (e.g., 1 kW) for backup power or micro-CHP systems. Even though the specific performance requirements differ between the stationary applications and are different from those for transportation applications, the main challenges are the same: reducing cost and increasing durability. While the acceptable price point for stationary fuel cell systems is considerably higher than that for transportation systems, current costs are still too high to be competitive with conventional/incumbent technology for most applications. Recent studies have indicated that prices range from ~\$4,000/kW for large prime power systems to over ~\$20,000/kW for small prime power (<11 kW), values that are considerably higher than DOE targets.<sup>14</sup> Additionally, the durability of stationary fuel cell systems in most instances does not match that of the incumbent technology. More specifics related to the challenges for particular stationary application segments are described below.

#### *Medium-Scale CHP/Distributed Generation (100 kW–3 MW Modular)*

PEMFCs, SOFCs, PAFCs, and MCFCs are being commercialized for medium-scale CHP and distributed generation applications. PAFCs and MCFCs have had the most success in this market due to their modularity, the quality of the waste heat generated, and their demonstrated durability (PAFC >80,000 and MCFC >40,000 hours). SOFCs are also making headway in this application as the technology further matures.

The initial costs for capital equipment, manufacturing processes, installation, and warranty associated with these systems need to be reduced. Challenges to reducing these costs for PAFCs and PAFCs such as PBI-type fuel cells include increasing catalyst performance by reducing or eliminating anion adsorption and developing

---

<sup>11</sup> DOE, *Quadrennial Technology Review: An Assessment of Energy Technologies and Research Opportunities*, Table 9.1.1 (Washington, D.C.: September 2015), <http://energy.gov/quadrennial-technology-review-2015>.

<sup>12</sup> S.C. Davis, S.W. Diegel, and R.G. Boundy, *Transportation Energy Data Book: Edition 33* (Technical Report ORNL-6990) (Oak Ridge, TN: Oak Ridge National Laboratory).

<sup>13</sup> DOE Fuel Cell Technologies Office, *2014 Fuel Cells Technology Market Report* (Technical Report) (Washington, D.C.: October 2015), <http://energy.gov/eere/fuelcells/downloads/2014-fuel-cell-technologies-market-report>.

<sup>14</sup> "Aggregated Price Data by Application, at Low Volume Production Levels," NREL, April 2015, [http://www.nrel.gov/hydrogen/images/cdp\\_lab\\_15.jpg](http://www.nrel.gov/hydrogen/images/cdp_lab_15.jpg).

more durable and stable catalysts and catalyst support materials that enable stable operation over the extended life of the fuel cell. Development of lower cost materials for the cell stack (e.g., replacement of Teflon in the cell stack) and the BOP is also a challenge.

For MCFCs, durability needs to be increased. In particular, more robust cathode materials must be developed to decrease the rate of cathode dissolution. The development of new electrolyte compositions to limit electrolyte loss, as well as new electrolyte supports with a more durable microstructure, is needed to prevent early stack failure. Tri-generation may provide an additional value stream for MCFCs by providing hydrogen to early markets, which would improve system economics. Common technical challenges for both MCFCs and PAFCs include reducing the system conditioning time and developing low-cost manufacturing methods as well as decreasing the cost of the fuel processor and the fuel cleanup system.

SOFC stacks have demonstrated durability in excess of 25,000 hours. The high operating temperature can lead to compatibility and reactivity issues among the various cell and stack components, especially over extended operating times. The ability of the stack to survive repeated thermal cycling and the relatively long start-up times are additional technical challenges. Reducing the operating temperature of SOFCs further will help resolve these challenges. FE is funding R&D work to develop SOFCs for medium-scale applications.

The lower operating temperature of traditional (low-temperature) PEMFC systems results in a lower tolerance to fuel impurities such as carbon monoxide relative to higher temperature systems and thus in more complex and costly fuel processing systems for PEMFCs when they operate on fuels other than hydrogen. While PEMFCs offer lower grade waste heat for CHP applications than SOFC, MCFC, and PAFC systems, high-level waste heat can be collected from the fuel processor. As is also true for the previously mentioned fuel cell types, PEMFC CHP systems may be used for tri-generation, where the hydrogen generated may provide an added value stream to the technology. Cost estimates for a 100-kW LT-PEMFC CHP system indicate that BOP and fuel processor costs are the dominant contributor to system costs, and must be reduced.<sup>15</sup> While low-temperature PEMFC systems have lower Pt loadings than PAFC systems, the cost of the catalyst is still high enough to be a major factor in overall cost. Both stack cost and Pt loading must be reduced. Additionally, increasing the temperature of operation could help simplify the fuel processor (possibly eliminating the low-temperature shift reactor), reduce costs, and provide higher quality waste heat from the fuel cell.

### *Micro CHP (<1–25 kW)*

Common challenges for micro CHP applications across fuel cell technology types lie in decreasing cost and increasing durability and cell component stability. For PEMFC systems, challenges also include decreasing fuel processor costs and raising operating temperatures. Substantial progress has been made in this application area, and tens of thousands of micro CHP systems have been installed in Japan and Europe under the ene-farm and ene-field programs, respectively. Durability of residential micro CHP systems has been improved to 70,000 hours for PEMFC systems. However, the price of these systems is still quite high, at approximately 1.7 million JPY for a 700-W system, the equivalent of \$22,000/kW.<sup>16</sup> This price is substantially higher than the DOE cost targets for micro CHP. The technical issues for SOFC systems designed for micro CHP applications are similar to those described in the Medium-Scale CHP/Distributed Generation section above. In portions of the United States where heating demand is low, the heat from CHP systems is larger than the heat requirements for most of the year, resulting in longer payback periods. The development of systems that can efficiently use this excess heat as part of a cooling system (combined heat cooling and power, CHCP) would be beneficial.

<sup>15</sup> M. Wei, "A Total Cost of Ownership Model for Design and Manufacturing Optimization of Fuel Cells in Stationary and Emerging Market Applications" (presented at the DOE Hydrogen and Fuel Cells Program and Vehicle Technologies Office Annual Merit Review and Peer Evaluation Meeting, Washington, D.C., June 19, 2014), [http://www.hydrogen.energy.gov/pdfs/review14/fc098\\_wei\\_2014\\_o.pdf](http://www.hydrogen.energy.gov/pdfs/review14/fc098_wei_2014_o.pdf).

<sup>16</sup> "Specifications of a Residential Fuel Cell Unit for a Detached House," Panasonic, [http://panasonic.co.jp/ap/FC/en\\_about\\_01.html](http://panasonic.co.jp/ap/FC/en_about_01.html).

### *Fuel Processing*

Stationary and distributed generation systems often include a fuel processing subsystem to convert raw fuel to clean hydrogen or synthesis gas for fuel cell consumption. The fuel processing system can have significant issues with fuel flexibility, durability, cost, impurity tolerance, thermal and physical integration, cold start-up time, and fuel cleanup. Current fuel processing systems need to be developed further to improve efficiency and reduce costs. To improve the efficacy of these systems, hardware and catalysts capable of generating fuel cell grade hydrogen or reformat from a variety of fuel sources (anaerobic digester gas, LPG, APG, landfill gas, biodiesel, and alcohols) are of interest. These fuels require varying degrees of treatment depending on the initial composition of the raw fuel, its heating value, and the type of fuel cell used. The impurities present in these fuels vary depending on the raw fuel type and its geographical origin and comprise a wide variety of compounds including various sulfur-containing compounds, siloxanes, halogens, and ammonia, among others. Military logistic fuels such as JP8 are not included here, but they are covered by U.S. Department of Defense funding.

Sulfur impurities, siloxanes, and halogenated compounds are impurities that have the greatest impact on gas cleanup system reliability, capital costs, and operating costs. Current technology can remove contaminants of concern and provide fuel that meets the purity requirements for fuel cell systems, but the costs are too high. Estimates showed the cleanup of biogas costs about 2 cents per kWh of electricity, and they make up 30% of the operating and maintenance costs in an anaerobic digester gas-fueled power plant.<sup>17</sup> The development of higher capacity sorbents and real-time online sensors to optimize the use of current sorbents will decrease the cleanup costs. The sorbents should preferably be fuel-flexible, environmentally friendly, and insensitive to water and hydrocarbons.

Currently, each plant is designed with a customized gas cleanup system to match the fuel and its quality and the fuel cell application. This limits potential cost savings from volume production. The development of a single cleanup system capable of purifying multiple fuels such as natural gas, biogas, landfill gas, APG, and other opportunity fuels will also decrease costs by increasing production volumes and will thus help to increase fuel cell deployment. Consideration of the few fuel cell plants in operation, additional studies, and plant demonstrations can provide much needed data for the industry on solutions for gas cleanup.

### *Reversible Fuel/Flow Cells*

Reversible fuel cells are of interest for energy storage applications and hold promise as an enabler for the implementation of intermittent renewable energy technologies. This technology allows for the storage of excess energy in the form of hydrogen during periods of low electricity demand that can then be used during times of peak demand. Reversible fuel cells are capable of operating in both power production (fuel cell) and energy storage (electrolysis) modes. Advantages of reversible fuel/flow cell technology include high round-trip efficiency (60–90%), decoupled power and energy capacity, long cycle life, low self-discharge rate, and reliable and stable performance. A key challenge to reversible fuel cells is maintaining electrode function and performance during repeated cycles between fuel cell and electrolysis modes.

Flow cells are often referred to as flow batteries and involve circulating the electrolyte through the cell from tanks external to the cell. When the electrolyte is spent, it must be externally recharged. Some types of flow cells, such as hydrogen/halogen cells, are closely related in structure to conventional fuel cells.

Cost and durability are barriers to the implementation of both reversible fuel cells and flow cells, but leveraging fuel cell R&D in the areas of membranes, electrocatalysts, electrode architectures, bipolar plates, and diffusion media for this technology would result in cost reduction and durability improvements.

---

<sup>17</sup> DOE Fuel Cell Technologies Office, *Gas Clean-Up for Fuel Cell Applications Workshop* (Technical Report) (Lemont, IL: Argonne National Laboratory, March 6–7, 2014), [http://energy.gov/sites/prod/files/2016/04/f30/fcto\\_gas\\_cleanup\\_workshop\\_report.pdf](http://energy.gov/sites/prod/files/2016/04/f30/fcto_gas_cleanup_workshop_report.pdf).



## Auxiliary Power Units

Fuel cells can provide clean, efficient auxiliary power for trucks, recreational vehicles, marine vessels (yachts, commercial ships), airplanes, locomotives, and similar applications that have significant auxiliary power demands. In many of these applications, the primary motive-power engines are often kept running solely for auxiliary loads. This practice is inefficient, resulting in significant additional fuel consumption and emissions. Fuel cell APUs are being considered for terrestrial, aviation, and maritime applications. APUs for heavy-duty vehicles represent a potential early market opportunity for fuel cell deployment. Significant fuel savings, as well as reduction in CO<sub>2</sub> and criteria pollutant emissions, may be achieved through more efficient fuel conversion and reduction in engine idling time. For the approximately 500,000 long-haul Class 7 and Class 8 trucks in the United States, emissions during overnight idling have been estimated to be 11 million tons of CO<sub>2</sub> and 55,000 tons of NO<sub>x</sub> annually.<sup>18</sup> A related application is refrigerated trucks, where diesel engines are used to power the transportation refrigeration units (TRUs). Emissions from idling and auxiliary power are likely to be the subject of increasing regulations in the future. Idling restrictions for heavy-duty highway vehicles have already been enacted in 28 states.<sup>19</sup> In 2008, the EPA adopted new requirements for limiting idling emissions from locomotives. In addition, noise pollution from diesel engines can be an issue and is regulated by local ordinances, making deliveries to these areas difficult.

The main challenges for APU applications are the cost and the combination of the transient operation of the APU and the harsh environment (shock and vibrations on the vehicle). In addition, the APU unit must fit in the available space and not add unnecessary weight to the vehicle. For long-haul trucks, fueling a fuel cell APU with a different fuel than the engine requires is not considered a viable option. Fuel cell systems with fuel reformers using the diesel onboard the vehicle and without adding additional requirements (i.e., no additional water for reforming) are being developed. For TRUs for refrigerated trucks, a hydrogen fueling option is considered to be marketable. Fuel cells for APU applications need to have increased specific power and power density to meet packaging requirements for heavy-duty trucks, and they need to reduce costs to decrease payback periods. See the Market Transformation chapter for more information.

## Early Market Applications

Early markets for fuel cells exist for applications that have less stringent cost and performance requirements than light-duty vehicles, and they are those where fuel cells offer advantages and can compete more readily with incumbent technologies. The introduction of fuel cells into the marketplace for these applications will help increase fuel cell manufacturing capacity and volumes and will help reduce production costs while increasing consumer familiarity with and acceptance of fuel cells. These applications include portable power systems, backup power installations, material handling equipment, and short-haul trucks. The material handling equipment and short-haul truck applications in particular share reduced infrastructure demands compared to light-duty vehicles. Short-haul trucks return to a central location each night to refuel, and as such they do not rely on an extensive public hydrogen refueling network. In some cases, these trucks may be able to take advantage of the existing hydrogen refueling infrastructure already in place for material handling equipment. Challenges in these markets are reducing cost of the systems themselves and of the hydrogen refueling stations.

Backup power installations, material handling equipment, yard dogs (tractor trailer type trucks used for moving freight trailers within a facility), and short-haul trucks are recognized as early markets for fuel cells. Fuel cell R&D advances will have a positive impact on fuel cell technology for these applications. Demonstration projects, including projects initially supported by the American Recovery and Reinvestment

<sup>18</sup> Argonne National Laboratory, "Long Haul Truck Idling Burns Up Profits" (Lemont, IL: 2015), [http://www.anl.gov/sites/anl.gov/files/es\\_long-haul\\_truck\\_idling\\_factsheet\\_Sept2015.pdf](http://www.anl.gov/sites/anl.gov/files/es_long-haul_truck_idling_factsheet_Sept2015.pdf).

<sup>19</sup> "Idling Regulations Compendium—Updated December 2015," ATRI, <http://atri-online.org/2014/10/20/idling-regulations-compendium/>.

Act of 2009, have highlighted these applications as areas for near-term fuel cell market penetration. Performance targets for backup power have been developed with input from the previous demonstration projects.

Portable power applications, including battery chargers, consumer electronics, handheld terminals, unattended security devices, notebook PCs, and emergency response mobile communications, also make up one of the main early markets for fuel cell technologies. Fuel cell systems with higher energy density, power density, and specific power than existing technologies can fill the increasing gap between energy demand and energy supply for these applications. Challenges for fuel cells for portable power include reducing cost (mainly by reducing catalyst loading), increasing efficiency (by reducing fuel crossover and increasing catalyst selectivity), and reducing the size of the system. Portable power R&D needs include the development of electrodes with higher activity and selectivity, reduction of methanol crossover, and decrease in system volume and weight. Additionally, total life-cycle efficiency improvement would have a positive impact on emissions reduction during operation and disposal. Flexible fuel capability (e.g., ethanol, butane) based on renewable fuels is also attractive.

### Technical Targets

Tables 3.4.3 through 3.4.10 list the DOE technical targets set specifically for integrated PEMFC power systems, fuel cell stacks, and components operating on direct hydrogen for light-duty transportation applications. These targets have been developed with input from the U.S. DRIVE Partnership, which includes automotive and energy companies, and specifically the Fuel Cell Technical Team. The guideline component targets are developed to assist component developers in evaluating progress without testing full systems. Tables 3.4.11 and 3.4.12 list the DOE technical targets for bus and backup power applications, respectively. Tables 3.4.13 and 3.4.14 list the DOE technical targets for CHP applications. These targets have been developed with input from developers of stationary fuel cell power systems. Tables 3.4.15 and 3.4.16 list the DOE technical targets for portable power and auxiliary power applications, respectively. In all cases, all targets must be achieved simultaneously; however, the status values are not necessarily from a single system. Where applicable, testing protocols for the technical targets listed below are identified and listed in appendix tables P.1 through P.11.

Table 3.4.3 Technical Targets: 80-kW <sub>e</sub> (net) Integrated Transportation Fuel Cell Power Systems Operating on Direct Hydrogen <sup>a</sup>				
Characteristic	Units	2015 Status	2020 Targets	Ultimate Targets
Peak energy efficiency <sup>b</sup>	%	60 <sup>c</sup>	65	70
Power density	W / L	640 <sup>d</sup>	650	850
Specific power	W / kg	659 <sup>e</sup>	650	650
Cost <sup>f</sup>	\$ / kW <sub>net</sub>	53 <sup>g</sup>	40	30
Cold start-up time to 50% of rated power @-20°C ambient temperature @+20°C ambient temperature	seconds	20 <sup>h</sup>	30	30
	seconds	<10 <sup>h</sup>	5	5
Start-up and shutdown energy <sup>i</sup> from -20°C ambient temperature from +20°C ambient temperature	MJ	7.5	5	5
	MJ	–	1	1
Durability in automotive drive cycle	hours	3,900 <sup>j</sup>	5,000 <sup>k</sup>	8,000 <sup>k</sup>
Start-up/shutdown durability <sup>l</sup>	cycles	–	5,000	5,000
Assisted start from low temperatures <sup>m</sup>	°C	–	-40	-40
Unassisted start from low temperatures <sup>n</sup>	°C	-30 <sup>n</sup>	-30	-30

<sup>a</sup> Targets exclude hydrogen storage, power electronics and electric drive.

<sup>b</sup> Ratio of DC output energy to the lower heating value of the input fuel (hydrogen). Peak efficiency occurs at less than 25% rated power.

<sup>c</sup> W. Sung, Y. Song, K. Yu, and T. Lim, “Recent Advances in the Development of Hyundai-Kia’s Fuel Cell Electric Vehicles,” SAE Int. J. Engines 3.1 (2010): 768–772, doi: 10.4271/2010-01-1089.

<sup>d</sup> J. Juriga, Hyundai Motor Group’s Development of the Fuel Cell Electric Vehicle, May 10th, 2012, [http://www.hydrogen.energy.gov/pdfs/htac\\_may2012\\_hyundai.pdf](http://www.hydrogen.energy.gov/pdfs/htac_may2012_hyundai.pdf).

<sup>e</sup> U. Eberle, B. Muller, and R von Helmolt, Energy & Environmental Science 5 (2012): 8780.

<sup>f</sup> Cost projected to high-volume production (500,000 systems per year).

<sup>g</sup> Cost at 500,000 systems per year based on an analysis of state-of-the-art components that have been developed and demonstrated primarily through the Fuel Cells sub-program at the laboratory scale. Additional efforts would be needed for integration of components into a complete automotive system that meets durability requirements in real-world conditions. DOE Hydrogen and Fuel Cells Program Record 15015, “Fuel Cell System Cost—2015.” [http://www.hydrogen.energy.gov/program\\_records.html](http://www.hydrogen.energy.gov/program_records.html)

<sup>h</sup> Based on average of status values reported at 2010 SAE World Congress (W. Sung, Y-I. Song, K-H Yu, T.W. Lim, SAE-2-10-01-1089). These systems do not necessarily meet other system-level targets.

<sup>i</sup> H<sub>2</sub> fuel energy (lower heating value) to include the fuel energy required to account for the electrical energy consumed from cold start.

<sup>j</sup> Average projected time to 10% voltage degradation for the fleet with the highest durability, as reported in J. Kurtz et al., “Fuel Cell Electric Vehicle Evaluation,” 2015 Annual Merit Review, [http://www.hydrogen.energy.gov/pdfs/review15/tv001\\_kurtz\\_2015\\_o.pdf](http://www.hydrogen.energy.gov/pdfs/review15/tv001_kurtz_2015_o.pdf) (slide 9). Testing reflects real-world driving, not a simulated drive cycle. Catalyst loading was not reported, and did not necessarily match the target value of 0.125 mg<sub>Pt</sub>/cm<sup>2</sup> (Table 3.4.7).

<sup>k</sup> Need to meet or exceed at temperatures of 80°C up to peak temperature. Based on polarization curve and durability testing protocols in Tables P.6 and P.7, with <10% drop in rated power after test.

<sup>l</sup> Measured according to protocol in Table P.8, with less than 5% decrease in voltage at 1.2 A/cm<sup>2</sup>.

<sup>m</sup> 8-hour soak at stated temperature must not impact subsequent achievement of targets.

<sup>n</sup> Press Release: Honda Demonstrates the FCX Concept Vehicle, Sep 25, 2006, <http://world.honda.com/news/2006/4060925FCXConcept/>; Associated Press, Toyota Develops a New Fuel Cell Hybrid, June 6, 2008, <http://www.nbcnews.com/id/25004758/>.

Table 3.4.4. Technical Targets: 80-kW <sub>e</sub> (net) Transportation Fuel Cell Stacks Operating on Direct Hydrogen <sup>a,b</sup>				
Characteristic	Units	2015 Status	2020 Targets	Ultimate Targets
Stack power density <sup>c</sup>	W / L	3,000 <sup>d</sup>	2,250	2,500
Stack specific power	W / kg	2,000 <sup>e</sup>	2,000	2,000
Performance @ 0.8 V <sup>f</sup>	mA / cm <sup>2</sup>	–	300	300
Cost <sup>g</sup>	\$ / kW <sub>net</sub>	26 <sup>h</sup>	20	15
Durability in automotive drive cycle <sup>i</sup>	hours	3,900 <sup>j</sup>	5,000	8,000
Start-up/shutdown durability <sup>k</sup>	cycles	–	5,000	5,000
Q/ΔT <sub>i</sub> <sup>l</sup>	kW/°C	1.9 <sup>m</sup>	1.45	1.45
Robustness (cold operation) <sup>n</sup>	see footnote	–	0.7	0.7
Robustness (hot operation) <sup>o</sup>	see footnote	–	0.7	0.7
Robustness (cold transient) <sup>p</sup>	see footnote	–	0.7	0.7

<sup>a</sup> Excludes hydrogen storage, power electronics, electric drive, and fuel cell ancillaries: thermal, water, and air management systems.

<sup>b</sup> Stacks operating on direct hydrogen and air at up to 150 kPa (absolute) inlet pressure.

<sup>c</sup> Power refers to net power (i.e., stack power minus projected BOP power). Volume is “box” volume, including dead space.

<sup>d</sup> Press Release: Toyota Motor Company Announces Status of its Environmental Technology Development, Future Plans, Sep 24, 2012, <http://www2.toyota.co.jp/en/news/12/09/0924.pdf>.

<sup>e</sup> M. Hanlon, “Nissan doubles power density with new Fuel Cell Stack,” Oct 13, 2011, <http://www.gizmag.com/nissan-doubles-power-density-with-new-fuel-cell-stack/20156/>.

<sup>f</sup> Measured using polarization curve protocol in Table P.6.

<sup>g</sup> Cost projected to high-volume production (500,000 stacks per year).

<sup>h</sup> Cost at 500,000 stacks per year based on an analysis of state-of-the-art components that have been developed and demonstrated primarily through the Fuel Cell Technologies Office Fuel Cells sub-program at the laboratory scale. Additional efforts would be needed for integration of components into a complete automotive system that meets durability requirements in real-world conditions. DOE Hydrogen and Fuel Cells Program Record 15015, “Fuel Cell System Cost—2015.” [http://www.hydrogen.energy.gov/program\\_records.html](http://www.hydrogen.energy.gov/program_records.html)

<sup>i</sup> Need to meet or exceed at temperatures of 80°C up to peak temperature. Based on polarization curve and durability testing protocols in Tables P.6 and P.7, with <10% drop in rated power after test.

<sup>j</sup> Average projected time to 10% voltage degradation for the fleet with the highest durability, as reported in J. Kurtz et al., “Fuel Cell Electric Vehicle Evaluation,” 2015 Annual Merit Review, [http://www.hydrogen.energy.gov/pdfs/review15/tv001\\_kurtz\\_2015\\_o.pdf](http://www.hydrogen.energy.gov/pdfs/review15/tv001_kurtz_2015_o.pdf) (slide 9). Testing reflects real-world driving.

<sup>k</sup> Catalyst loading was not reported, and did not necessarily match the target value of 0.125 mg<sub>Pt</sub>/cm<sup>2</sup>.

<sup>l</sup> Measured according to protocol in Table P.8, with less than 5% decrease in voltage at 1.2 A/cm<sup>2</sup>.

<sup>m</sup> Q/ΔT<sub>i</sub> = [Stack power (90 kW) x (1.25 V - Voltage at Rated Power) / (Voltage at Rated Power)] / [(Stack Coolant out temp (°C) - Ambient temp (40°C)]. Target assumes 90 kW stack gross power required for 80 kW net power, and is to be measured using the polarization curve protocol in Table P.6 except inlet humidification and coolant outlet temperature. Inlet humidification is up to 40% RH and coolant outlet temperature is up to maximum operating temperature. Cathode and anode inlet pressures are up to 150 kPa (absolute).

<sup>n</sup> Based on a voltage of 0.67 V and stack coolant outlet temperature of 80°C.

<sup>o</sup> Ratio of fuel cell stack voltage at 30°C to fuel cell stack voltage at 80°C operation at 1.0 A/cm<sup>2</sup>, measured using the protocol for a polarization curve found in Table P.6. A 25°C dew point is used only for 30°C operation.

<sup>p</sup> Ratio of fuel cell stack voltage at 90°C to fuel cell stack voltage at 80°C operation at 1.0 A/cm<sup>2</sup>, measured using the protocol for a polarization curve found in Table P.6. A 59°C dew point is used for both 90°C and 80°C operations.

<sup>p</sup> Ratio of fuel cell stack voltage at 30°C transient to fuel cell stack voltage at 80°C steady-state operation at 1.0 A/cm<sup>2</sup>, measured using the protocol for a polarization curve found in Table P.6. A 25°C dew point is used only for 30°C operation. 30°C transient operation is at 1 A/cm<sup>2</sup> for at least 15 minutes then lowered to 0.1 A/cm<sup>2</sup> for 3 minutes without changing operating conditions. After 3 minutes, the current density is returned to 1 A/cm<sup>2</sup>. The voltage is measured 5 seconds after returning to 1 A/cm<sup>2</sup>.

Table 3.4.5 Technical Targets: Membrane Electrode Assemblies for Transportation Applications			
Characteristic	Units	2015 Status	2020 Targets
Cost <sup>a</sup>	\$ / kW <sub>net</sub>	17 <sup>b</sup>	14
Durability with cycling	Hours	2,500 <sup>c</sup>	5,000 <sup>d</sup>
Start-up/shutdown durability <sup>e</sup>	Cycles	–	5,000
Performance @ 0.8 V <sup>f</sup>	mA / cm <sup>2</sup>	240 <sup>g</sup>	300
Performance @ rated power <sup>h</sup> (150 kPa <sub>abs</sub> )	mW / cm <sup>2</sup>	810 <sup>i</sup>	1,000
Robustness (cold operation) <sup>j</sup>	see footnote	1.09 <sup>k</sup>	0.7
Robustness (hot operation) <sup>l</sup>	see footnote	0.87 <sup>k</sup>	0.7
Robustness (cold transient) <sup>m</sup>	see footnote	0.84 <sup>k</sup>	0.7

<sup>a</sup> Costs projected to high volume production (500,000 80-kW<sub>net</sub> systems per year).

<sup>b</sup> Cost when producing sufficient MEAs for 500,000 systems per year. DOE Hydrogen and Fuel Cells Program Record 15015, “Fuel Cell System Cost—2015.” [http://www.hydrogen.energy.gov/program\\_records.html](http://www.hydrogen.energy.gov/program_records.html). Cost includes all MEA components, including frames and gaskets.

<sup>c</sup> Time until 10% decrease in voltage at 1.0–1.5 A/cm<sup>2</sup> for a Gore MEA using a 510 catalyst (anode/cathode loading of 0.2/0.4 mg<sub>Pt</sub>/cm<sup>2</sup>) operated on durability test protocol in Table P.7. Rod Borup and Rangachary Mukundan (LANL), private communication and 2013 Annual Merit Review presentation ([http://www.hydrogen.energy.gov/pdfs/review13/fc016\\_mukundan\\_2013\\_o.pdf](http://www.hydrogen.energy.gov/pdfs/review13/fc016_mukundan_2013_o.pdf)). Higher durability values have been reported elsewhere (e.g. 3,900 hours in on-the-road testing, Table 3.4.3), but these higher values were not measured using the drive cycle specified in Table P.7.

<sup>d</sup> Need to meet or exceed at temperatures of 80°C up to peak temperature. Based on polarization curve and durability testing protocols in Table P.6 and Table P.7, with <10% drop in rated power after test.

<sup>e</sup> Measured according to protocol in Table P.8, with less than 5% decrease in voltage at 1.2 A/cm<sup>2</sup>.

<sup>f</sup> Measured using polarization curve protocol in Table P.6.

<sup>g</sup> Kongkanand et al. (General Motors), “High-Activity Dealloyed Catalysts,” 2014 Annual Progress Report, [http://www.hydrogen.energy.gov/pdfs/progress14/v\\_a\\_9\\_kongkanand\\_2014.pdf](http://www.hydrogen.energy.gov/pdfs/progress14/v_a_9_kongkanand_2014.pdf)

<sup>h</sup> Measured using polarization curve protocol in Table P.6, but any temperature up to maximum operating temperature may be used, with maximum inlet RH of 40%. Rated power operating point depends on MEA temperature and is defined as the voltage at which  $V = 77.6 / (22.1 + T[^\circ\text{C}])$ , based on target of  $Q/\Delta T_i = 1.45 \text{ kW}/^\circ\text{C}$  and definition of  $Q/\Delta T_i$  from Table 3.4.4, with an approximation of MEA temperature as equal to stack coolant outlet temperature.

<sup>i</sup> Areal power density of 810 mW/cm<sup>2</sup> at 150 kPa<sub>abs</sub> and 1,060 mW/cm<sup>2</sup> at 250 kPa<sub>abs</sub>. A. Steinbach et al. (3M), “High-Performance, Durable, Low-Cost Membrane Electrode Assemblies for Transportation Applications,” 2014 Annual Merit Review, [http://www.hydrogen.energy.gov/pdfs/review14/fc104\\_steinbach\\_2014\\_o.pdf](http://www.hydrogen.energy.gov/pdfs/review14/fc104_steinbach_2014_o.pdf)

<sup>j</sup> Ratio of voltage at 30°C to voltage at 80°C during operation at 1.0 A/cm<sup>2</sup>, measured using the protocol for a polarization curve found in Table P.6. A 25°C dew point is used only for 30°C operation.

<sup>k</sup> Based on testing performed at LANL using a Gore MEA with high cathode loading (0.1/0.4 mg<sub>Pt</sub>/cm<sup>2</sup> anode/cathode) and SGL GDLs (25BC/25BC). Rod Borup, presentation to the Fuel Cell Tech Team, July 15, 2015.

<sup>l</sup> Ratio of voltage at 90°C to voltage at 80°C during operation at 1.0 A/cm<sup>2</sup>, measured using the protocol for a polarization curve found in Table P.6. A 59°C dew point is used for both 90°C and 80°C operations.

<sup>m</sup> Ratio of voltage at 30°C transient operation to voltage at 80°C steady-state operation at 1.0 A/cm<sup>2</sup>, measured using the protocol for a polarization curve found in Table P.6. A 25°C dew point is used only for 30°C operation. 30°C transient operation is at 1 A/cm<sup>2</sup> for at least 15 minutes then lowered to 0.1 A/cm<sup>2</sup> for 3 minutes without changing operating conditions. After 3 minutes, the current density is returned to 1 A/cm<sup>2</sup>. The voltage is measured 5 seconds after returning to 1 A/cm<sup>2</sup>.

Table 3.4.6 Technical Targets: Membranes for Transportation Applications			
Characteristic	Units	2015 Status	2020 Targets
Maximum oxygen crossover <sup>a</sup>	mA / cm <sup>2</sup>	2.4 <sup>b</sup>	2
Maximum hydrogen crossover <sup>a</sup>	mA / cm <sup>2</sup>	1.1 <sup>c</sup>	2
Area specific proton resistance at:			
Maximum operating temperature and water partial pressures from 40–80 kPa	ohm cm <sup>2</sup>	0.072 (120°C, 40 kPa) <sup>c</sup>	0.02
80°C and water partial pressures from 25–45 kPa	ohm cm <sup>2</sup>	0.027 (25 kPa) <sup>c</sup>	0.02
30°C and water partial pressures up to 4 kPa	ohm cm <sup>2</sup>	0.027 (4 kPa) <sup>c</sup>	0.03
-20°C	ohm cm <sup>2</sup>	0.1 <sup>b</sup>	0.2
Maximum operating temperature	°C	120 <sup>c</sup>	120
Minimum electrical resistance	ohm cm <sup>2</sup>	>5,600 <sup>c</sup>	1,000
Cost <sup>d</sup>	\$ / m <sup>2</sup>	17 <sup>e</sup>	20
Durability <sup>f</sup>			
Mechanical	Cycles until >15 mA/cm <sup>2</sup> H <sub>2</sub> crossover <sup>g</sup>	23,000 <sup>c</sup>	20,000
Chemical	Hours until >15 mA/cm <sup>2</sup> crossover or >20% loss in OCV	742 <sup>c</sup>	>500
Combined chemical/mechanical	Cycles until >15 mA/cm <sup>2</sup> crossover or >20% loss in OCV	–	20,000

<sup>a</sup> Tested in MEA on O<sub>2</sub> or H<sub>2</sub>, 80°C, fully humidified gases, 1 atm total pressure. For H<sub>2</sub> test methods, see M. Inaba et. al. *Electrochimica Acta*, 51, 5746, 2006. For O<sub>2</sub> test methods, see Zhang et. al. *Journal of The Electrochemical Society*, 160, F616-F622, 2013.

<sup>b</sup> 14 μm PFIA membrane with nanofiber support. M. Yandrasits (3M), private communication, February 1, 2016.

<sup>c</sup> Reinforced and chemically stabilized PFIA membrane. M. Yandrasits et al. (3M), U.S. Department of Energy Hydrogen and Fuel Cells Program 2015 Annual Progress Report, [https://www.hydrogen.energy.gov/pdfs/progress15/v\\_b\\_1\\_yandrasits\\_2015.pdf](https://www.hydrogen.energy.gov/pdfs/progress15/v_b_1_yandrasits_2015.pdf).

<sup>d</sup> Costs projected to high-volume production (500,000 80 kW systems per year).

<sup>e</sup> Cost when producing sufficient membrane for 500,000 systems per year. DOE Hydrogen and Fuel Cells Program Record 15015, “Fuel Cell System Cost—2015.” [http://www.hydrogen.energy.gov/program\\_records.html](http://www.hydrogen.energy.gov/program_records.html).

<sup>f</sup> Measured according to protocols in Table P.3, Table P.4, and Table P.5.

<sup>g</sup> For air or N<sub>2</sub> testing, an equivalent crossover metric of 0.1 sccm/cm<sup>2</sup> at a 50 kPa pressure differential, 80°C, and 100%RH may be used as an alternative.



Table 3.4.7 Technical Targets: Electrocatalysts for Transportation Applications

Characteristic	Units	2015 Status	2020 Targets
Platinum group metal total content (both electrodes) <sup>a</sup>	g / kW (rated, <sup>b</sup> gross) @ 150 kPa (abs)	0.16 <sup>c,d</sup>	0.125
Platinum group metal (pgm) total loading (both electrodes) <sup>a</sup>	mg PGM / cm <sup>2</sup> electrode area	0.13 <sup>c</sup>	0.125
Mass activity <sup>e</sup>	A / mg PGM @ 900 mV <sub>IR-free</sub>	>0.5 <sup>f</sup>	0.44
Loss in initial catalytic activity <sup>e</sup>	% mass activity loss	66 <sup>c</sup>	<40
Loss in performance at 0.8 A/cm <sup>2,e</sup>	mV	13 <sup>c</sup>	<30
Electrocatalyst support stability <sup>g</sup>	% mass activity loss	41 <sup>h</sup>	<40
Loss in performance at 1.5 A/cm <sup>2,g</sup>	mV	65 <sup>h</sup>	<30
PGM-free catalyst activity	A / cm <sup>2</sup> @ 0.9 V <sub>IR-free</sub>	0.016 <sup>i</sup>	>0.044 <sup>j</sup>

<sup>a</sup> PGM content and loading targets may have to be lower to achieve system cost targets.

<sup>b</sup> Rated power operating point depends on MEA temperature and is defined as the voltage at which  $V = 77.6 / (22.1 + T[^\circ\text{C}])$ , based on target of  $Q/\Delta T_i = 1.45 \text{ kW}/^\circ\text{C}$  and definition of  $Q/\Delta T_i$  from Table 3.4.4, with an approximation of MEA temperature as equal to stack coolant outlet temperature.

<sup>c</sup> Steinbach et al. (3M), "High-Performance, Durable, Low-Cost Membrane Electrode Assemblies for Transportation Applications," 2014 Annual Merit Review, [http://www.hydrogen.energy.gov/pdfs/review14/fc104\\_steinbach\\_2014\\_o.pdf](http://www.hydrogen.energy.gov/pdfs/review14/fc104_steinbach_2014_o.pdf)

<sup>d</sup> Based on MEA gross power at 150 kPa abs. Measured at 0.692 V and 90°C, satisfying  $Q/\Delta T < 1.45 \text{ kW}/^\circ\text{C}$ . At 250 kPa abs status is 0.12 g/kW.

<sup>e</sup> Measured using protocol in Table P.1.

<sup>f</sup> Kongkanand et al. (General Motors), "High-Activity Dealloyed Catalysts," 2014 Annual Merit Review, [http://www.hydrogen.energy.gov/pdfs/review14/fc087\\_kongkanand\\_2014\\_o.pdf](http://www.hydrogen.energy.gov/pdfs/review14/fc087_kongkanand_2014_o.pdf)

<sup>g</sup> Measured using protocol in Table P.2.

<sup>h</sup> B. Popov et al., "Development of Ultra-low Doped-Pt Cathode Catalysts for PEM Fuel Cells," 2015 Annual Merit Review, [http://www.hydrogen.energy.gov/pdfs/review15/fc088\\_popov\\_2015\\_o.pdf](http://www.hydrogen.energy.gov/pdfs/review15/fc088_popov_2015_o.pdf).

<sup>i</sup> P. Zelenay (LANL), "Non-Precious Metal Fuel Cell Cathodes: Catalyst Development and Electrode Structure Design," 2016 Annual Merit Review, [https://www.hydrogen.energy.gov/pdfs/review16/fc107\\_zelenay\\_2016\\_o.pdf](https://www.hydrogen.energy.gov/pdfs/review16/fc107_zelenay_2016_o.pdf).

<sup>j</sup> Target is equivalent to PGM catalyst mass activity target of 0.44 A/mg<sub>PGM</sub> at 0.1 mg<sub>PGM</sub>/cm<sup>2</sup>.

Table 3.4.8 Technical Targets: Bipolar Plates for Transportation Applications

Characteristic	Units	2015 Status	2020 Targets
Cost <sup>a</sup>	\$ / kW <sub>net</sub>	7 <sup>b</sup>	3
Plate weight	kg / kW <sub>net</sub>	<0.4 <sup>c</sup>	0.4
Plate H <sub>2</sub> permeation coefficient <sup>d</sup>	Std cm <sup>3</sup> /(sec cm <sup>2</sup> Pa) @ 80°C, 3 atm 100% RH	0 <sup>e</sup>	<1.3 x 10 <sup>-14,f</sup>
Corrosion, anode <sup>g</sup>	μA / cm <sup>2</sup>	No active peak <sup>h</sup>	<1 and no active peak
Corrosion, cathode <sup>i</sup>	μA / cm <sup>2</sup>	<0.1 <sup>c</sup>	<1
Electrical conductivity	S / cm	>100 <sup>j</sup>	>100
Areal specific resistance <sup>k</sup>	ohm cm <sup>2</sup>	0.006 <sup>h</sup>	<0.01
Flexural strength <sup>l</sup>	MPa	>34 (carbon plate) <sup>m</sup>	>25
Forming elongation <sup>n</sup>	%	20–40 <sup>o</sup>	40

<sup>a</sup> Costs projected to high volume production (500,000 80 kW systems per year), assuming MEA meets performance target of 1,000 mW/cm<sup>2</sup>.

<sup>b</sup> Cost when producing sufficient plates for 500,000 systems per year. DOE Hydrogen and Fuel Cells Program Record 15015, "Fuel Cell System Cost—2015." [http://www.hydrogen.energy.gov/program\\_records.html](http://www.hydrogen.energy.gov/program_records.html).

<sup>c</sup> C.H. Wang (Treadstone), "Low-cost PEM Fuel Cell Metal Bipolar Plates," 2012 Annual Progress Report, [http://www.hydrogen.energy.gov/pdfs/progress12/v\\_h\\_1\\_wang\\_2012.pdf](http://www.hydrogen.energy.gov/pdfs/progress12/v_h_1_wang_2012.pdf).

<sup>d</sup> Per the standard gas transport test (ASTM D1434).

<sup>e</sup> C.H. Wang (Treadstone), private communication, October 2014.

<sup>f</sup> Blunk, *et al*, J. Power Sources 159 (2006) 533–542.

<sup>g</sup> pH 3 0.1ppm HF, 80°C, peak active current <1x10<sup>-6</sup> A/cm<sup>2</sup> (potentiodynamic test at 0.1 mV/s, -0.4V to +0.6V (Ag/AgCl)), de-aerated with Ar purge.

<sup>h</sup> Kumar, M. Ricketts, and S. Hirano, "Ex-situ evaluation of nanometer range gold coating on stainless steel substrate for automotive polymer electrolyte membrane fuel cell bipolar plate," Journal of Power Sources 195 (2010): 1401–1407, September 2009.

<sup>i</sup> pH 3 0.1ppm HF, 80°C, passive current <5x10<sup>-8</sup> A/cm<sup>2</sup> (potentiostatic test at +0.6V (Ag/AgCl) for >24h, aerated solution.

<sup>j</sup> O. Adrianowycz (GrafTech), "Next Generation Bipolar Plates for Automotive PEM Fuel Cells," 2009 Annual Progress Report, [http://www.hydrogen.energy.gov/pdfs/progress09/v\\_g\\_2\\_adrianowycz.pdf](http://www.hydrogen.energy.gov/pdfs/progress09/v_g_2_adrianowycz.pdf).

<sup>k</sup> Includes interfacial contact resistance (on as received and after potentiostatic test) measured both sides per Wang, *et al*. J. Power Sources 115 (2003) 243–251 at 200 psi (138 N/cm<sup>2</sup>).

<sup>l</sup> ASTM-D 790-10 Standard Test Method for Flexural Properties of Unreinforced and Reinforced Plastics and Electrical Insulating Materials.

<sup>m</sup> D. Haack *et al*. (Porvair), "Carbon-Carbon Bipolar Plates," 2007 Annual Progress Report,

[http://www.hydrogen.energy.gov/pdfs/progress07/v\\_b\\_3\\_haack.pdf](http://www.hydrogen.energy.gov/pdfs/progress07/v_b_3_haack.pdf).

<sup>n</sup> Per ASTM E8M-01 Standard Test Methods for Tension Testing of Metallic Materials, or demonstrate ability to stamp generic channel design with width, depth, and radius.

<sup>o</sup> M. Brady *et al*. (Oak Ridge National Laboratory), "Nitrided Metallic Bipolar Plates," 2010 Annual Progress Report,

[http://www.hydrogen.energy.gov/pdfs/progress10/v\\_1\\_1\\_brady.pdf](http://www.hydrogen.energy.gov/pdfs/progress10/v_1_1_brady.pdf).

Table 3.4.9 Technical Targets: Air Compression System for 80-kW <sub>e</sub> Transportation Fuel Cell Systems Operating on Direct Hydrogen			
Characteristic	Units	2015 Status	2020 Targets
Input power <sup>a</sup> at full flow <sup>b</sup> (with / without expander)	kW <sub>e</sub>	11.0 / 17.3	8 / 14
Combined motor and motor controller efficiency at full flow <sup>b</sup>	%	80	90
Compressor / expander efficiency at full flow <sup>b</sup>	%	71 / 73	75 / 80
Input power at 25% flow <sup>c</sup> (with / without expander)	kW <sub>e</sub>	2.3 / 3.3	1.0 / 2.0
Combined motor / motor controller efficiency at 25% flow <sup>c</sup>	%	57	80
Compressor / expander efficiency at 25% flow <sup>c</sup>	%	62 / 64	65 / 70
Input power at idle <sup>d</sup> (with / without expander)	W <sub>e</sub>	600 / 765	200 / 200
Combined motor / motor controller efficiency at idle <sup>d</sup>	%	35	70
Compressor / expander efficiency at idle <sup>d</sup>	%	61 / 59	60 / 60
Durability <sup>e</sup>	h	–	5,000
Number of start-up and shutdown cycles	–	–	250,000
Turndown ratio (max/min flow rate)	–	20	20
Noise at maximum flow	dBA at 1 m	–	65
Transient time for 10–90% of maximum flow	s	1	1
System volume <sup>f</sup>	L	15	15
System weight <sup>f</sup>	kg	22	15
System cost <sup>g</sup>	\$	750 <sup>h</sup>	500

<sup>a</sup> Electrical input power to motor controller when bench testing fully integrated system. Fully integrated system includes control system electronics, air filter, and any additional air flow that may be used for cooling.

<sup>b</sup> Compressor: 92 g/s flow rate, 2.5 bar (absolute) discharge pressure; 40°C, 25% RH inlet conditions. Expander: 88 g/s flow rate, 2.2 bar (absolute) inlet pressure, 70°C, 100% RH inlet conditions.

<sup>c</sup> Compressor: 23 g/s flow rate, minimum 1.5 bar (absolute) discharge pressure; 40°C, 25% RH inlet conditions. Expander: 23 g/s flow rate, 1.4 bar (absolute) inlet pressure, 70°C, 100% RH inlet conditions.

<sup>d</sup> Compressor: 4.6 g/s flow rate, minimum 1.2 bar (absolute) discharge pressure; 40°C, 25% RH inlet conditions. Expander: 4.6 g/s flow rate, < compressor discharge pressure, 70°C, 20% RH inlet conditions.

<sup>e</sup> Durability testing performed according to protocol in Table P.10.

<sup>f</sup> Weight and volume include the motor, motor controller.

<sup>g</sup> Cost target based on a manufacturing volume of 500,000 units per year.

<sup>h</sup> Includes cost of compressor, expander, and motor controller manufactured at a volume of 500,000 systems per year. DOE Hydrogen and Fuel Cells Program Record 15015, “Fuel Cell System Cost—2015.” [http://www.hydrogen.energy.gov/program\\_records.html](http://www.hydrogen.energy.gov/program_records.html).

Table 3.4.10 Technical Targets: Cathode Humidification System and Humidifier Membrane for 80-kW <sub>e</sub> Transportation Fuel Cell Systems Operating on Direct Hydrogen			
Characteristic	Units	2015 Status <sup>a</sup>	2020 Targets
Maximum operating temperature	°C	110–125	>95
Maximum pressure differential between wet and dry sides	kPa	75	75
Maximum pressure drop at full flow (each side)	kPa	<3	3.5
Water transfer at full flow <sup>b</sup>	g s <sup>-1</sup>	7.4 at BOL, 5.5 after 5,000 h	5
Durability <sup>c</sup>	h	5,000	5,000
Maximum air leakage at full flow	%	0.5	0.5
Volume	L	4.3	5
Weight	kg	2.7	5
Humidifier membrane water transfer flux at full flow <sup>b</sup>	g min <sup>-1</sup> cm <sup>-2</sup>	>0.03	0.025
System cost <sup>d</sup>	\$	81 <sup>e</sup>	100
Membrane cost <sup>d</sup>	\$/m <sup>2</sup>	20 <sup>e</sup>	10

<sup>a</sup> Gore final report DE-EE0000465, Materials and Modules for Low Cost, High Performance Fuel Cell Humidifiers, Feb. 2013.

<sup>b</sup> Dry air in: 3000 SLPM dry gas flow, 183 kPa (absolute), 80°C, 0% RH. Wet air in: 2600 SLPM dry gas flow, 160 kPa (absolute), 80°C, 85% RH.

<sup>c</sup> Durability testing performed according to protocol in Table P.11.

<sup>d</sup> Cost projected to high-volume production (500,000 80 kW systems per year).

<sup>e</sup> DOE Hydrogen and Fuel Cells Program Record 15015, “Fuel Cell System Cost—2015.” [http://www.hydrogen.energy.gov/program\\_records.html](http://www.hydrogen.energy.gov/program_records.html).

Table 3.4.11 Technical Targets: Fuel Cell Transit Buses

Characteristic	Units	2015 Status	2016 Targets	2020 Targets
Bus lifetime	years/miles	0.25–4.9/7,900–117,000 <sup>a</sup>	12/500,000	12/500,000
Power plant lifetime <sup>b,c</sup>	hours	20,000 <sup>a</sup>	18,000	25,000
Bus availability	%	40–92 <sup>a</sup>	85	90
Fuel fills <sup>d</sup>	per day	1 <sup>a</sup>	1 (< 10 min)	1 (< 10 min)
Bus cost <sup>e</sup>	\$	800,000 <sup>f</sup>	1,000,000	600,000
Power plant cost <sup>b,e</sup>	\$	60,000–120,000 <sup>g</sup>	450,000	200,000
Hydrogen storage cost	\$	100,000 <sup>h</sup>	75,000	50,000
Road call frequency (bus/fuel cell system)	miles between road calls	1,800–6,800/9,000–104,000 <sup>a</sup>	3,500/15,000	4,000/20,000
Operation time	hours per day/days per week	7–21/5–7 <sup>a</sup>	20/7	20/7
Scheduled and unscheduled maintenance cost <sup>i</sup>	\$/mile	0.54–1.33 <sup>a</sup>	0.75	0.40
Range	miles	240–340 <sup>a</sup>	300	300
Fuel economy	miles per gallon diesel equivalent	5.6–7.7 <sup>a</sup>	8	8

<sup>a</sup> L. Eudy et al., “Fuel Cell Buses in U.S. Transit Fleets: Current Status 2015,” Technical Report NREL/TP-5400–64974, December 2015. <http://www.nrel.gov/docs/fy16osti/64974.pdf>.

<sup>b</sup> The power plant is defined as the fuel cell system and the battery system. The fuel cell system includes supporting subsystems such as the air, fuel, coolant, and control subsystems. Power electronics, electric drive, and hydrogen storage tanks are excluded.

<sup>c</sup> According to an appropriate duty cycle.

<sup>d</sup> Multiple sequential fuel fills should be possible without increase in fill time.

<sup>e</sup> Cost projected to a production volume of 400 systems per year. This production volume is assumed for analysis purposes only, and does not represent an anticipated level of sales.

<sup>f</sup> Paul Jenné, “Fuel Cell Electric Bus Projects - Status and Outlook from an Industry Perspective,” Presentation at the 2015 International Fuel Cell Bus Workshop, <http://gofuelcellbus.com/index.php/workshops/2015-international-fuel-cell-bus-workshop-registration>.

<sup>g</sup> \$40,000–\$100,000, for fuel cell system only, based on Monte Carlo analysis of projected manufacturing cost at 200–1,000 buses per year. B.D. James et al. (Strategic Analysis, Inc.), “Mass Production Cost Estimation of Direct H<sub>2</sub> PEM Fuel Cell Systems for Transportation Applications: 2014 Update,” final report. Batteries estimated to cost an additional \$20,000 per system (B.D. James, private communication, May 2015).

<sup>h</sup> DOE Hydrogen and Fuel Cells Program Record #12012, “Fuel Cell Bus Targets,” [http://www.hydrogen.energy.gov/program\\_records.html](http://www.hydrogen.energy.gov/program_records.html).

<sup>i</sup> Excludes mid-life overhaul of power plant.

**Table 3.4.12 Technical Targets: Fuel Cell Backup Power Systems (1–10kW<sub>e</sub>)  
Operating on Direct Hydrogen**

Characteristic	Units	2015 Status <sup>a</sup>	2020 Targets
Lifetime	Years	10	15
Durability <sup>b</sup>	hours	8,000	10,000
Energy efficiency <sup>c</sup>	%	50	60
Mean time between failures	years	5	5
Ambient temperature range	°C	-20 to 40	-50 to 50
Noise	dB at 1 m	65	60
Start-up time <sup>d</sup>	seconds	60	15
Availability	%	99.7	96.3
Equipment cost <sup>e</sup>	\$/kW	6,100 <sup>f</sup>	1,000
Annual maintenance cost <sup>e</sup>	\$/kW	30	20
Annualized total cost of ownership <sup>g</sup>	\$/kW	500	200

<sup>a</sup> Unless otherwise stated, status based on input from RFI DE-FOA-0000738.

<sup>b</sup> Time until 10% voltage degradation when operated on a backup power duty cycle.

<sup>c</sup> Ratio of DC output energy from the power plant to the lower heating value of the input fuel (hydrogen), averaged over duty cycle.

<sup>d</sup> Time indicated is start-up time for the fuel cell. The backup power system, including hybridized batteries, is expected to provide uninterruptible power.

<sup>e</sup> Excludes tax credits and subsidies.

<sup>f</sup> NREL, “Current Fuel Cell System Low Volume Price by Application,” [http://www.nrel.gov/hydrogen/images/cdp\\_lab\\_15.jpg](http://www.nrel.gov/hydrogen/images/cdp_lab_15.jpg).

<sup>g</sup> Annualized cost of ownership, including cost of capital equipment, installation, operation and maintenance, fuel, and fuel storage. Based on a 5 kW system with 10 year lifetime.



**Table 3.4.13 Technical Targets: 1–25kW<sub>e</sub> Residential and Light Commercial Combined Heat and Power and Distributed Generation Fuel Cell Systems Operating on Natural Gas<sup>a</sup>**

Characteristic	Units	2015 Status	2020 Targets
Electrical efficiency at rated power <sup>b</sup>	% (LHV)	34–40	>45 <sup>c</sup>
CHP energy efficiency <sup>d</sup>	% (LHV)	80–90	90
Equipment cost <sup>e</sup> , 5-kW <sub>avg</sub> system <sup>f</sup>	\$/kW	2,300–2,800 <sup>g</sup>	1,500
Transient response (10 - 90% rated power)	min	5	2
Start-up time from 20°C ambient temperature	min	10	20
Degradation with cycling <sup>h</sup>	%/1,000 h	<2%	0.3%
Operating lifetime <sup>i</sup>	h	12,000-70,000	60,000
System availability <sup>j</sup>	%	97	99

<sup>a</sup> Pipeline natural gas delivered at typical residential distribution line pressures.

<sup>b</sup> Regulated AC net/LHV of fuel.

<sup>c</sup> Higher electrical efficiencies (e.g. 60% using SOFC) are preferred for non-CHP applications.

<sup>d</sup> Ratio of regulated AC net output energy plus recovered thermal energy to the LHV of the input fuel. For inclusion in CHP energy-efficiency calculation, heat must be available at a temperature sufficiently high to be useful in space and water heating applications. Provision of heat at 80°C or higher is recommended.

<sup>e</sup> Complete system, including all necessary components to convert natural gas to electricity suitable for grid connection, and heat exchangers and other equipment for heat rejection to conventional water heater, and/or hydronic or forced air heating system. Includes all applicable tax and markup. Based on projection to high-volume production (50,000 units per year).

<sup>f</sup> kW<sub>avg</sub> is the average output (AC) electric power delivered over the life of system while unit is running.

<sup>g</sup> Battelle preliminary 2015 cost assessment of stationary CHP systems, range represents different technologies (SOFC vs PEMFC) at manufacturing volumes of 50,000 units per year.

<sup>h</sup> Durability testing should include effects of transient operation, start-up, and shutdown.

<sup>i</sup> Time until >20% net power degradation.

<sup>j</sup> Percentage of time the system is available for operation under realistic operating conditions and load profile. Unavailable time includes time for scheduled maintenance.

Table 3.4.14 Technical Targets <sup>a</sup> : 100 kW–3 MW Combined Heat and Power and Distributed Generation Fuel Cell Systems Operating on Natural Gas <sup>b</sup>			
Characteristic	Units	2015 Status <sup>c</sup>	2020 Targets
Electrical efficiency at rated power <sup>d</sup>	% (LHV)	42–47	>50 <sup>e</sup>
CHP energy efficiency <sup>f</sup>	% (LHV)	70–90	90
Equipment cost, natural gas	\$/kW	1,200 <sup>g</sup> –4,500 <sup>h</sup>	1,000 <sup>i</sup>
Installed cost, natural gas	\$/kW	2,400 <sup>g</sup> –5,500 <sup>h</sup>	1,500 <sup>i</sup>
Equipment cost, biogas	\$/kW	3,200–6,500 <sup>j</sup>	1,400 <sup>i</sup>
Installed cost, biogas	\$/kW	4,900–8,000 <sup>j</sup>	2,100 <sup>i</sup>
Number of planned/forced outages over lifetime	–	50	40
Operating lifetime <sup>k</sup>	h	40,000–80,000	80,000
System availability <sup>l</sup>	%	95%	99%

<sup>a</sup> Includes fuel processor, stack and ancillaries.

<sup>b</sup> Pipeline natural gas delivered at typical residential distribution line pressures.

<sup>c</sup> Status varies by technology.

<sup>d</sup> Ratio of regulated AC net output energy to the lower heating value (LHV) of the input fuel.

<sup>e</sup> Higher electrical efficiencies (e.g. 60% using SOFC) are preferred for non-CHP applications.

<sup>f</sup> Ratio of regulated AC net output energy plus recovered thermal energy to the LHV of the input fuel. For inclusion in CHP energy-efficiency calculation, heat must be available at a temperature sufficiently high to be useful in space and water heating applications. Provision of heat at 80°C or higher is recommended.

<sup>g</sup> M. Wei, 100 kW LTPEMFC, projection at volume of 1,000 systems/year,

[http://www.hydrogen.energy.gov/pdfs/review14/fc098\\_wei\\_2014\\_o.pdf](http://www.hydrogen.energy.gov/pdfs/review14/fc098_wei_2014_o.pdf).

<sup>h</sup> DOE Hydrogen and Fuel Cells Program Record 11014, “Medium-scale CHP Fuel Cell System Targets,”

[https://www.hydrogen.energy.gov/pdfs/11014\\_medium\\_scale\\_chp\\_target.pdf](https://www.hydrogen.energy.gov/pdfs/11014_medium_scale_chp_target.pdf).

<sup>i</sup> Includes projected cost advantage of high-volume production (totaling 100 MW per year).

<sup>j</sup> Assumed \$2,500/kW higher cost to operate on biogas than on hydrogen

([https://www.hydrogen.energy.gov/pdfs/11014\\_medium\\_scale\\_chp\\_target.pdf](https://www.hydrogen.energy.gov/pdfs/11014_medium_scale_chp_target.pdf)).

<sup>k</sup> Time until >10% net power degradation.

<sup>l</sup> Percentage of time the system is available for operation under realistic operating conditions and load profile. Unavailable time includes time for scheduled maintenance.

Table 3.4.15 Technical Targets: Portable Power Fuel Cell Systems  
(5–50 Watts / 100–200 Watts)<sup>a</sup>

Characteristic	Units	2015 Status	Ultimate Targets
Specific power <sup>b</sup>	W/kg	23 <sup>h</sup> / 25 <sup>i</sup>	45 / 50
Power density <sup>b</sup>	W/L	24 <sup>h</sup> / 30 <sup>i</sup>	55 / 70
Specific energy <sup>b,c</sup>	Wh/kg	121 <sup>j</sup> / 450 <sup>j</sup>	650 / 640
Energy density <sup>b,c</sup>	Wh/L	200 <sup>i</sup> / 300 <sup>i,j</sup>	650 / 900
Cost <sup>d</sup>	\$/W	15 <sup>i</sup> / 15 <sup>i</sup>	7 / 5
Durability <sup>e,f</sup>	hours	1,500 <sup>i</sup> / 2,000 <sup>i</sup>	5,000 / 5,000
Mean time between failures <sup>f,g</sup>	hours	500 <sup>i</sup> / 500 <sup>i</sup>	5,000 / 5,000

- <sup>a</sup> These targets are technology neutral and make no assumption about the type of fuel cell technology or type of fuel used. In addition to meeting these targets, portable power fuel cells are expected to operate safely, providing power without exposing users to hazardous or unpleasant emissions, high temperatures, or objectionable levels of noise. Portable power fuel cells are also expected to be compatible with the requirements of portable electronic devices, including operation under a range of ambient temperature, humidity, and pressure conditions, and exposure to freezing conditions, vibration, and dust. They should be capable of repeatedly turning off and on, and should have turndown capabilities required to match the dynamic power needs of the device. For widespread adoption, portable power fuel cell systems should minimize life-cycle environmental impact through the use of reusable fuel cartridges, recyclable components, and low-impact manufacturing techniques.
- <sup>b</sup> This is based on rated net power of the total fuel cell system, including fuel tank, fuel, and any hybridization batteries. In the case of fuel cells embedded in other devices, only device components required for power generation, power conditioning, and energy storage are included. Fuel capacity is not specified, but the same quantity of fuel must be used in calculation of specific power, power density, specific energy, and energy density.
- <sup>c</sup> Efficiency of 35% is recommended to enable high specific energy and energy density.
- <sup>d</sup> Cost includes material and labor costs required to manufacture the fuel cell system and any required auxiliaries (e.g., refueling devices). Cost is defined at production rates of 25,000 and 10,000 units per year for 5–50 W and 100–200 W units, respectively.
- <sup>e</sup> Durability is defined as the time until the system rated power degrades by 20%, though for some applications higher or lower levels of power degradation may be acceptable.
- <sup>f</sup> Testing should be performed using an operating cycle that is realistic and appropriate for the target application, including effects from transient operation, start-up and shutdown, and offline degradation.
- <sup>g</sup> Mean Time Between Failures (MTBF) includes failures of any system components that render the system inoperable without maintenance.
- <sup>h</sup> Status calculated based on commercial products from myFC at [www.myfcpower.com/pages/jaq](http://www.myfcpower.com/pages/jaq)
- <sup>i</sup> DOE Hydrogen and Fuel Cells Program Record 11009, [www.hydrogen.energy.gov/pdfs/11009\\_portable\\_fuel\\_cell\\_targets.pdf](http://www.hydrogen.energy.gov/pdfs/11009_portable_fuel_cell_targets.pdf)
- <sup>j</sup> Status calculated based on commercial products from ultracell at [www.ultracell-llc.com](http://www.ultracell-llc.com)

Table 3.4.16 Technical Targets: Fuel Cell Auxiliary Power Units (1 to 10 kW <sub>e</sub> ) Operating on Ultra-low Sulfur Diesel Fuel			
Characteristic	Units	2015 Status	2020 Targets
Electrical efficiency at rated power <sup>a</sup>	% (LHV)	29 <sup>b</sup>	40
Power density	W/L	16 <sup>b</sup>	40
Specific power	W/kg	18 <sup>b</sup>	45
Factory cost, system <sup>c</sup>	\$/kW <sub>e</sub>	2,100 <sup>d</sup>	1,000
Transient response (10 to 90% rated power)	min	5 <sup>e</sup>	2
Start-up time from: 20°C Standby conditions <sup>f</sup>	min	70 <sup>b</sup> -	30 5
Degradation with cycling <sup>g</sup>	%/1,000 h	2.6 <sup>e</sup>	1
Operating lifetime <sup>g,h</sup>	h	3,000 <sup>e</sup>	20,000
System availability <sup>i</sup>	%	97 <sup>e</sup>	99

<sup>a</sup> Regulated DC net/LHV of fuel.

<sup>b</sup> DESTA—Demonstration of 1st European SOFC Truck APU, Programme Review Days 2015, [http://www.fch.europa.eu/sites/default/files/8-DESTA\\_PRD2015%20%28ID%202848595%29.pdf](http://www.fch.europa.eu/sites/default/files/8-DESTA_PRD2015%20%28ID%202848595%29.pdf).

<sup>c</sup> Cost includes materials and labor costs to produce system. Cost defined at 50,000 unit/year production of a 5 kW system. Today's low-volume cost is expected to be higher than quoted status. Allowable cost is expected to be higher than the target for systems with rated power below 5 kW, and lower than the target for systems with rated power above 5 kW.

<sup>d</sup> Modeled cost of a 5 kW SOFC APU system produced at 50,000 units/year. F. Eubanks et al., "Stationary and Emerging Market Fuel Cell System Cost Analysis—Auxiliary Power Units," 2015 Annual Merit Review, slide 20, [https://www.hydrogen.energy.gov/pdfs/review14/fc097\\_contini\\_2014\\_o.pdf](https://www.hydrogen.energy.gov/pdfs/review14/fc097_contini_2014_o.pdf)

<sup>e</sup> DOE Hydrogen Program Record 11001, "Revised APU Targets," [https://www.hydrogen.energy.gov/pdfs/11001\\_apu\\_targets.pdf](https://www.hydrogen.energy.gov/pdfs/11001_apu_targets.pdf).

<sup>f</sup> Standby conditions may be at or above ambient temperature depending on operating protocol.

<sup>g</sup> Durability testing should include, at minimum, daily cycles to stand-by condition, and weekly cycles to full off condition (ambient temperature). The system should be able to meet durability criteria during and after exposure to vibration associated with transportation and highway operation, and during operation in a range of ambient temperature from -40 to 50°C, a range of ambient relative humidity from 5% to 100%, and in dust levels up to 2 mg/m<sup>3</sup>.

<sup>h</sup> Time until >20% net power degradation.

<sup>i</sup> Percentage of time the system is available for operation under realistic operating conditions and load profile. Scheduled maintenance does not count against system availability.

### 3.4.5 Technical Barriers

#### A. Durability

Fuel cells have not yet demonstrated a level of durability comparable to the incumbent technologies in the main application areas of transportation and stationary power generation. In these applications, realistic operating conditions can include impurities in the fuel and air, starting and stopping, freezing and thawing, and humidity and load cycles that result in stresses on the chemical and mechanical stability of the fuel cell materials, components, and interfaces. While some of the ageing and degradation mechanisms are known, effective mitigation strategies to provide the required lifetime are still lacking.

Fuel cell systems have yet to demonstrate the needed 5,000 hour durability in automotive drive cycles. Although the required lifetime in automotive applications is much shorter than for stationary applications, the rapid cycling and frequent stops and starts make meeting the durability requirements more challenging. Durability results from second-generation vehicle demonstrations indicated that they were far short of the durability requirement, with the highest average projected time to 10% voltage degradation of approximately 2,500 hours. In the laboratory environment with newer technology NREL determined an average projected durability of 3,900 hours (time to 10% degradation) for automotive applications.<sup>20</sup> However, the Pt loadings were not reported for these data, and it is unclear if the loadings were appropriate to meet the cost targets. Higher loadings would improve durability at the expense of further distancing the technology from the cost targets. In addition, there are considerable gaps between degradation observed in the lab and degradation observed in the field for some motive power applications. Key obstacles to overcoming the durability limitations are understanding catalyst and membrane degradation and mitigating performance degradation at high power conditions. Tolerance to air, fuel, and system derived impurities also needs to be established.

Stationary fuel cells must achieve greater than 60,000 hours durability to compete against other distributed power generation systems and to allow for an acceptable return on investment to the end-user. The operating temperatures required for high-temperature fuel cells place stringent durability requirements on materials and components, including the separator, electrolyte, electrolyte support, and electrode. Improved durability under start-up and transient operation is also required for high-temperature fuel cells. Durability of phosphoric acid based (PBI-type) fuel cells needs to be increased to conventional PAFC systems, for which established durability comes at a high cost. Research is also needed to understand failure mechanisms and develop mitigation strategies. Accelerated testing protocols need to be updated to enable projection of durability and to allow for timely iterations and improvements in the technology. State-of-the-art systems must also be benchmarked.

Regardless of application, system BOP component durability needs to be improved. The majority of fuel cell system failures and forced outages (~90% in automotive systems<sup>21</sup> and ~90% in micro CHP systems<sup>22</sup>) are the result of non-fuel cell stack BOP events.

#### B. Cost

For fuel cells and fuel cell systems to be commercially viable, significant reduction in cost is required. Materials and manufacturing costs for stack components need to be reduced. To make fuel cell stacks competitive, lower costs are needed for high-performance membranes, high-performance catalysts with ultra-

---

<sup>20</sup> J. Kurtz, "Analysis of Laboratory Fuel Cell Technology Status-Degradation" (presented as a 2015 annual progress report for the DOE Hydrogen and Fuel Cells Program, Washington, D.C., December, 2015; V-174), [http://www.hydrogen.energy.gov/pdfs/progress15/v\\_f\\_10\\_kurtz\\_2015.pdf](http://www.hydrogen.energy.gov/pdfs/progress15/v_f_10_kurtz_2015.pdf).

<sup>21</sup> "CDP #64: Fuel Cell Vehicle Maintenance By System" (results from the Controlled Hydrogen Fleet and Infrastructure Demonstration and Validation Project), [http://www.nrel.gov/hydrogen/docs/cdp/cdp\\_64.ppt](http://www.nrel.gov/hydrogen/docs/cdp/cdp_64.ppt).

<sup>22</sup> P. Mocoteguy (presented at the International Workshop on Degradation Issues of Fuel Cells, Hersonessos, Crete, Greece, Sept. 19–21, 2007).

low or PGM-free loading, and lighter, corrosion-resistant bipolar plates. PEMFCs, phosphoric acid based (PBI-type) fuel cells, and PAFCs suffer from reliance on relatively high priced PGM catalysts. PGM cost is particularly important for stationary power applications, where the need for enhanced durability and reformate tolerance requires the use of high PGM loadings; in the case of PAFCs, the PGM cost has been reported to account for 4 to 6% of the current installed costs of the power plant.<sup>23</sup> Furthermore, for automotive applications, the cost of the electrocatalyst is projected to be the largest single component of the cost of a PEMFC system when manufactured at high volume.<sup>24</sup> The use of PGM-free catalysts will further reduce the cost of MEAs, but performance of these catalysts must be dramatically improved. For high-temperature fuel cells, such as MCFCs and SOFCs, PGM-free materials are available, but research is required to lower stack component costs, such as for cells and interconnects, as well as for system BOP components required for high-temperature operation.

BOP components and subsystems specifically designed for use in fuel cell systems need further development in order to achieve cost targets. For automotive fuel cell systems, system BOP constitutes about half the cost of the system.<sup>20</sup> For stationary primary power applications, the relatively high cost of the fuel processor needs to be addressed. One of the most important issues that is not specific to any fuel cell type is the development of a cost-effective process and subsystem for removing contaminants, especially those found in renewable fuels, which would considerably reduce overall cost and allow for fuel flexibility. For high-temperature fuel cells, some of the BOP components (e.g., heat exchangers) must operate at elevated temperatures, and so the temperature limitations imposed by other components (e.g., anode recycle blower) can negatively impact the overall system efficiency.

### C. Performance

Fuel cell system performance must improve while simultaneously reducing cost and increasing durability to allow for market penetration and the inherent environmental benefits of the technology. This section describes some areas that affect fuel cell performance.

#### *Cell Issues*

Improved cell performance is required to ensure lower cost and enhanced durability for the full range of fuel cell technologies. For instance, poor cathode kinetics cause overpotentials of 0.4 V or greater in state-of-the-art PEMFCs operating under typical conditions. This overpotential represents a loss at the cathode of approximately one-third of the theoretically available energy from a fuel cell. Therefore, cathode R&D is needed to meet efficiency targets simultaneously with other targets. Mitigation of catalyst dissolution/degradation during operation of low-temperature and high-temperature fuel cells drives higher performance and leads to lower cost. Power densities, especially at the higher voltages required for high-efficiency operation, are currently too low to meet cost and packaging targets. Also, performance loss is observed at high current densities with cathodes that have an ultra-low PGM loading; the source of this loss is under investigation. Higher power densities, across the technologies, could be achieved by increasing the ionic conductivity of the electrolyte and decreasing polarization losses of the electrodes. Novel electrolytes could achieve higher conductivities, but materials must meet operation requirements. Membrane performance under the extremes of automotive drive cycles and the steady-state lifetime requirements for stationary applications have not been established. For low temperature fuel cells, conductivity under low humidity conditions needs to be increased, and stable membrane performance at higher temperatures for both proton- and anion-conducting polymer electrolyte fuel cells needs to be achieved.

---

<sup>23</sup> R.J. Remick, D. Wheeler, and P. Singh, *MCFC and PAFC R&D Workshop Summary Report* (Washington, D.C.: U.S. Department of Energy, 2010), [http://www1.eere.energy.gov/hydrogenandfuelcells/pdfs/mcfc\\_pafc\\_workshop\\_summary.pdf](http://www1.eere.energy.gov/hydrogenandfuelcells/pdfs/mcfc_pafc_workshop_summary.pdf).

<sup>24</sup> B.D. James, J.M. Moton, and W.G. Colella, *Mass Production Cost Estimation of Direct H<sub>2</sub> PEM Fuel Cell Systems for Transportation Applications: 2014 Update* (Technical Report) (Arlington, VA: Strategic Analysis, Inc., 2014), <http://energy.gov/eere/fuelcells/fuel-cell-technical-publications>.



The chemical and electrical interface between the electrode and the electrolyte material can affect performance, with a poor interface resulting in higher electronic resistance and low utilization. Also, new electrolyte materials may require redesign of the electrode structure and interface to maintain performance. Interfacial contact resistance at the electrode/bipolar plate interface needs to be further reduced.

### *Stack Water Management*

Effective management of the water produced in low-temperature fuel cells is needed to alleviate flooding and/or drying out of the membrane over the full operating temperature range. Ineffective water management leads to liquid-phase water blockage and mass-transport-limited performance (flooding) or, alternatively, decreased proton conductivity (drying out). Transportation-based and stationary fuel cells must be able to operate in environments where ambient temperatures may fall below 0°C, which is a challenge for low-temperature fuel cells. R&D is needed to improve the designs of the gas diffusion layers, gas flow fields in bipolar plates, catalyst layers, and membranes in these fuel cells to enable effective water management and operation in subfreezing environments.

### *System Thermal and Water Management*

Thermal and water management processes include heat and water use, cooling, and humidification. Improved heat utilization, cooling, and humidification techniques are needed. The low operating temperature of PEM fuel cells results in a relatively small difference between the fuel cell stack operating temperature and ambient air temperature, which is not conducive to conventional heat rejection approaches and limits the use of heat generated by the fuel cell (approximately 50% of the energy supplied by the fuel). More efficient heat recovery systems, improved system designs, advanced heat exchangers and/or higher temperature operation of current systems are needed to utilize the low-grade heat and achieve the most efficient (electrical and thermal) systems, particularly for distributed power generation. The high quality heat generated by high-temperature fuel cells leads to higher overall system efficiencies; however, the need to remove heat generated by the high-temperature stacks can complicate stack/system design, as well as limit the operating power density and cell size. Improved techniques to manage water during start-up and shutdown at subfreezing temperatures are also needed.

### *System Air Management*

Compressors/expanders specifically designed for low-temperature and high-temperature fuel cell applications are needed to minimize parasitic power consumption, while meeting packaging and cost requirements.

### *System Start-Up and Shutdown Time and Energy/Transient Operation*

Automotive fuel cell systems must start rapidly from any ambient condition with minimal fuel consumption. For stationary power applications, and especially for high-temperature fuel cells, rapid start-up and thermal cycling during operation is not anticipated, but transient times need to be minimized and stacks need to be designed to survive thermal upsets. Strategies to address start-up and shutdown time and energy such as the use of hybrid systems and/or stored hydrogen are needed. Fuel cell power plants will also be required to follow load variations, which are dependent on application.

## 3.4.6 Technical Task Descriptions

Table 3.4.17 Technical Task Descriptions		
Task	Description	Barriers
1	<p><b>Catalysts/Electrodes</b></p> <p><i>Develop Improved Catalysts</i></p> <ul style="list-style-type: none"> <li>• Reduce/eliminate PGM loading of catalysts</li> <li>• Increase the specific and mass activities of catalysts</li> <li>• Increase the durability/stability of catalysts during potential cycling</li> <li>• Increase the tolerance of catalysts to air, fuel, and system-derived impurities</li> <li>• Test and characterize catalysts</li> <li>• Develop PGM-free catalysts for PEMFCs (oxygen reduction reaction)</li> <li>• Develop PGM-free catalysts for AMFCs (hydrogen oxidation reaction and oxygen reduction reaction)</li> <li>• Increase catalyst utilization</li> <li>• Develop catalysts with high durability at high current density</li> </ul> <p><i>Develop Improved Catalyst Supports</i></p> <ul style="list-style-type: none"> <li>• Reduce corrosion of catalyst supports</li> <li>• Improve appropriate support conductivity</li> <li>• Develop lower cost catalyst support materials and structures</li> <li>• Develop viable supports that allow increased loading and/or thickness of PGM-free catalyst layer</li> </ul> <p><i>Catalyst process scale up</i></p> <ul style="list-style-type: none"> <li>• Design and demonstrate small-scale production of newly-developed and promising catalysts (minimum viable product)</li> </ul> <p><i>Optimize Electrode Design and Assembly</i></p> <ul style="list-style-type: none"> <li>• Optimize catalyst/support interactions and microstructure.</li> <li>• Develop and streamline high-throughput combinatorial experimental and modeling tools for PGM-free catalyst and electrode R&amp;D</li> </ul>	A, B, C
2	<p><b>Electrolytes</b></p> <p><i>Identify and develop novel electrolytes (PEMs, alkaline membranes, high-temperature electrolytes and matrices)</i></p> <ul style="list-style-type: none"> <li>• Improve electrolyte conductivity, for both proton and alkaline systems, over the entire temperature and humidity operating range</li> <li>• Increase the mechanical/chemical/thermal stability of electrolytes over the entire temperature and humidity operating range</li> <li>• Reduce/eliminate fuel cross-over</li> </ul> <p><i>Fabricate Membranes from Ionomers</i></p> <ul style="list-style-type: none"> <li>• Design scalable membrane fabrication processes</li> <li>• Increase the mechanical/chemical/thermal stability of the membrane over the entire temperature and humidity operating range (e.g., up to 95 - 120°C for transportation systems, and &gt;120°C for CHP systems)</li> <li>• Reduce the cost of membranes</li> </ul> <p><i>Perform Membrane/Electrolyte Testing and Characterization to Improve Durability</i></p>	A, B, C

Table 3.4.17 Technical Task Descriptions		
Task	Description	Barriers
	<ul style="list-style-type: none"> <li>Evaluate the tolerance of the electrolyte material to air, fuel, and system-derived impurities</li> <li>Evaluate the mechanical stability of the membrane with relative humidity (RH) cycling</li> <li>Identify chemical and mechanical degradation mechanisms</li> <li>Develop strategies for mitigating degradation in performance</li> </ul> <p><i>Membrane process scale up</i></p> <ul style="list-style-type: none"> <li>Demonstrate small-scale production of newly-developed and promising membranes (minimum viable product)</li> </ul>	
3	<p><b>Membrane Electrode Assemblies, Cells, and Other Stack Components</b></p> <p><i>Integrate Membranes/Electrolytes and Electrodes</i></p> <ul style="list-style-type: none"> <li>Integrate catalysts with membranes and GDLs into MEAs</li> <li>Optimize mechanical and chemical interactions of the catalyst, support, ionomer, and membrane</li> <li>Develop methods to minimize CO<sub>2</sub> migration in alkaline fuel cells</li> </ul> <p><i>Test, Analyze, and Characterize MEAs</i></p> <ul style="list-style-type: none"> <li>Characterize MEAs/cells before, during, and after fabrication and operation</li> <li>Test cells, MEAs, and short stacks</li> </ul> <p><i>MEA integration process scale up</i></p> <ul style="list-style-type: none"> <li>Demonstrate small-scale production of newly-developed and promising MEAs (minimum viable product)</li> </ul> <p><i>Improve Performance of Bipolar Plates</i></p> <ul style="list-style-type: none"> <li>Decrease weight and volume</li> <li>Develop coatings to eliminate plate corrosion and maintain conductivity</li> </ul> <p><i>Decrease Cost of Bipolar Plates</i></p> <ul style="list-style-type: none"> <li>Evaluate the use of different low-cost materials and coatings to improve corrosion resistance</li> </ul> <p><i>Improve Durability of Bipolar Plates</i></p> <ul style="list-style-type: none"> <li>Identify degradation mechanisms</li> <li>Develop strategies/technologies for mitigating degradation</li> </ul>	A, B, C
4	<p><b>Fuel Cell Performance and Durability</b></p> <p><i>Improve MEA and component stability and durability</i></p> <ul style="list-style-type: none"> <li>Improve MEA/cell stability under voltage and humidity cycling</li> <li>Develop techniques to mitigate effects of air, fuel, and system-derived impurities</li> <li>Demonstrate robustness</li> </ul> <p><i>Expand MEA/Cell Operating Range</i></p> <ul style="list-style-type: none"> <li>Address freeze/thaw issues</li> <li>Expand temperature and humidity range</li> </ul> <p><i>Improve MEA/cell Performance</i></p> <ul style="list-style-type: none"> <li>Optimize three-phase boundary for improved transport properties.</li> </ul>	A, B, C

Table 3.4.17 Technical Task Descriptions		
Task	Description	Barriers
	<ul style="list-style-type: none"> <li>Minimize interfacial resistances</li> <li>Improve performance at high power conditions</li> </ul> <p><i>Develop Protocols for Testing</i></p> <ul style="list-style-type: none"> <li>Develop accelerated testing to project durability for stationary fuel cell applications</li> </ul> <p><i>Improve Technical Understanding/Characterization</i></p> <ul style="list-style-type: none"> <li>Develop, validate, and use models to address impurity effects</li> <li>Develop, validate, and use models to address durability/degradation</li> <li>Develop, validate, and use models to address transport issues and their effects on fuel cell operation</li> <li>Develop and validate component performance models using most recent data</li> <li>Identify long term stack failure mechanisms through experimentation</li> <li>Optimize MEA and stack water management, including freeze/thaw issues</li> <li>Mitigate system issues</li> <li>Improve performance and durability of higher temperature fuel cells (MCFC, PAFC) experimentally determine long-term stack failure mechanisms</li> </ul>	
5	<p><b>System BOP Components</b></p> <p><i>Develop Air Management Technologies (Blowers, Compressors/Expanders) for Transportation Applications</i></p> <ul style="list-style-type: none"> <li>Meet performance, packaging, and cost requirements</li> <li>Minimize parasitic power</li> </ul> <p><i>Develop Humidifiers for Transportation Applications</i></p> <ul style="list-style-type: none"> <li>Increase efficiency, durability, and reliability</li> <li>Develop humidification materials and concepts</li> <li>Minimize parasitic power</li> <li>Develop lightweight, low cost materials to enable compact humidifiers</li> </ul> <p><i>Develop Low Cost Sensors for Fuel Cell Systems</i></p> <ul style="list-style-type: none"> <li>Develop durable, low cost sensors for high-temperature fuel cell systems</li> </ul>	A, B, C
6	<p><b>Fuel Cell Systems</b></p> <p><i>Develop Stationary Fuel Cell Systems for Distributed Generation (DG) and backup power including CHP</i></p> <ul style="list-style-type: none"> <li>Improve system durability</li> <li>Improve stack performance with reformat</li> <li>Increase system electrical and thermal efficiency</li> <li>Reduce cost</li> <li>Develop fuel-flexible, impurity-tolerant, durable fuel processors</li> </ul> <p><i>Develop Auxiliary Power Units</i></p> <ul style="list-style-type: none"> <li>Develop fuel cell system that operates on reformat</li> <li>Design, build and test APUs under real-world conditions</li> <li>Reduce cost</li> </ul> <p><i>Develop Backup Power and Early Market Technologies</i></p>	A, B, C

Table 3.4.17 Technical Task Descriptions		
Task	Description	Barriers
	<ul style="list-style-type: none"> <li>Design, build, and test systems for early market applications under real-world conditions</li> <li>Design, build, and test systems for backup power applications under real-world conditions</li> <li>Reduce cost</li> </ul> <p><i>Develop Fuel Flexible Processors for Stationary Fuel Cells Applications</i></p>	
7	<p><b>Testing and Technical Assessments</b></p> <p><i>Perform Cost Analysis of Stationary, Portable, and Transportation Applications</i></p> <ul style="list-style-type: none"> <li>Perform cost analyses for automotive and bus applications</li> <li>Perform cost analyses for stationary power and early market applications including APUs, backup power, and material handling (forklifts)</li> </ul> <p><i>Annually Update Technology Status</i></p> <p><i>Conduct Trade-Off Analysis</i></p> <ul style="list-style-type: none"> <li>Rated power design points vs. performance and efficiency</li> <li>Start-up energy and start-up time</li> <li>Hydrogen quality level vs. durability and performance</li> </ul> <p><i>Perform Independent Testing to Characterize Component and Stack Properties Before, During, and After Operation</i></p>	A, B, C

### 3.4.7 Milestones

The following chart shows the interrelationship of milestones and tasks for the Fuel Cells sub-program from FY 2016 through FY 2020. All milestones are to be assessed under prescribed test conditions according to appropriate protocols listed in the appendix.



# Fuel Cells Sub-program Milestone Chart

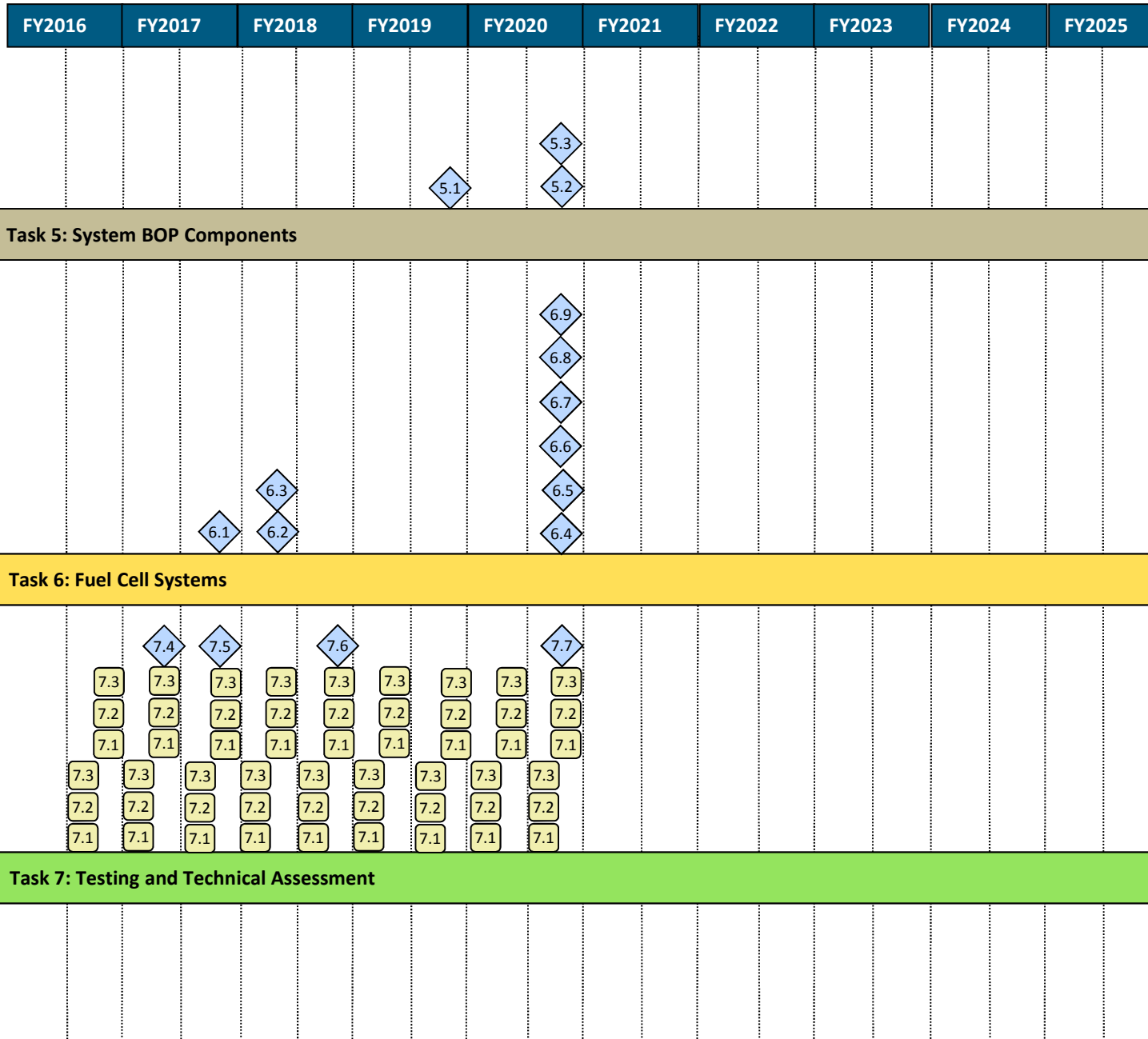



Task 1: Catalysts/Electrodes	
1.1	Improve the catalyst specific power of fuel cells (kW per gram of PGM) to 6.9 kW/g <sub>PGM</sub> in a 50 cm <sup>2</sup> or greater MEA. (4Q, 2016)
1.2	Improve the catalyst specific power of fuel cells (kW per gram of PGM) to 7.2 kW/g <sub>PGM</sub> in a 50 cm <sup>2</sup> or greater MEA. (4Q, 2017)
1.3	Develop PAFCs or similar technologies with advanced catalysts and catalyst layer deposition methods to enable 50% reduction in PGM loading compared to the baseline of 0.7 mg/cm <sup>2</sup> (anode + cathode). (4Q, 2018)
1.4	Improve the catalyst specific power of fuel cells (kW per gram of PGM) to 7.5 kW/g <sub>PGM</sub> in a 50 cm <sup>2</sup> or greater MEA. (4Q, 2018)
1.5	Develop a low-cost support that demonstrates at least: 100 mS/cm proton conductivity, 5 S/cm electron conductivity, >50 m <sup>2</sup> /g BET surface area, and <10% mass loss on cycling between 1.0 and 1.5V at 0.5V/s and cycling between 0.6 and 1.0V under 1,000 load cycles. (4Q, 2018)
1.6	Demonstrate a PGM-free catalyst with an activity of 0.044 A/cm <sup>2</sup> at 0.88 V in a PEMFC MEA. (4Q, 2018)
1.7	Demonstrate less than 40% loss of initial mass activity and less than 30 mV loss at 1.5 A/cm <sup>2</sup> after 30,000 potential cycles for cathode catalyst in MEA with total PGM loading of less than 0.125 mg/cm <sup>2</sup> electrode area. (1Q, 2019)
1.8	Improve the catalyst specific power of fuel cells (kW per gram of PGM) to 7.8 kW/g <sub>PGM</sub> in a 50 cm <sup>2</sup> or greater MEA. (4Q, 2019)
1.9	Develop PGM-free catalysts demonstrating alkaline membrane fuel cell peak power performance of > 600 mW/cm <sup>2</sup> under hydrogen/air (maximum pressure of 1.5 atm) in PGM-free MEA. (2Q, 2020)
1.10	Improve the catalyst specific power of fuel cells (kW per gram of PGM) to 8 kW/g <sub>PGM</sub> in a 50 cm <sup>2</sup> or greater MEA. (4Q, 2020)
1.11	Demonstrate a PGM-free catalyst with an activity of 0.044 A/cm <sup>2</sup> at 0.9 V in a PEMFC MEA. (4Q, 2020)
1.12	Develop and streamline high-throughput combinatorial experimental and modeling tools for PGM-free catalyst and electrode development. (3Q, 2016 thru 4Q, 2020)

Task 2: Electrolytes	
2.1	Develop a PEM membrane for transportation with an area specific resistance $\leq 0.02 \text{ ohm cm}^2$ at 95°C and 40 kPa water partial pressure that is durable for 20,000 voltage cycles and that has 500 hours chemical durability testing. (2Q, 2017)
2.2	Develop anion-exchange membranes with an area specific resistance $\leq 0.1 \text{ ohm cm}^2$ , that is maintained for 500 hours during testing at 600 mA/cm <sup>2</sup> at T >60 °C. (2Q, 2017)
2.3	Develop MCFC electrolyte matrix structure and chemistry with 10-year life incorporating stable supports and electrolyte management/retention. (4Q, 2017)
2.4	Demonstrate electrolytes for high-temperature fuel cells with a projected durability of 80,000 hours in a stack for 10,000 h. (2Q, 2019)
2.5	Develop a PEM membrane for transportation with an area specific resistance $\leq 0.02 \text{ ohm cm}^2$ at 120°C and 40 kPa water partial pressure that is durable for 20,000 voltage cycles and that has 500 hours chemical durability testing. (1Q, 2020)
2.6	Develop a membrane with performance similar to current supported perfluorosulfonic acid (PFSA) membranes with 50% decreased projected costs compared to supported PFSA membranes. (4Q, 2020)

Task 3: Membrane Electrode Assemblies, Cells, and Other Stack Components	
3.1	Demonstrate an MEA with catalyst specific power (kW per gram of PGM) of 6.9 kW/g <sub>PGM</sub> . (4Q, 2016)
3.2	Demonstrate a phosphoric acid-based MEA with reduced anion poisoning resulting in a 25% increase in areal power density compared to baseline value of 160 mW/cm <sup>2</sup> . (3Q, 2017)
3.3	Evaluate short stack with improved MEAs against 2020 membrane and MEA targets. (4Q, 2017)
3.4	Demonstrate alkaline membrane fuel cell peak power performance > 600 mW/cm <sup>2</sup> on H <sub>2</sub> /O <sub>2</sub> (maximum pressure of 1.5 atm) in MEA with a total loading of ≤ 0.125 mg <sub>PGM</sub> /cm <sup>2</sup> . (4Q, 2017)
3.5	Report on status of MEA/cell durability to meet stationary fuel cell target of >60,000 hours. (2Q, 2018)
3.6	Demonstrate alkaline membrane fuel cell initial performance of 0.6 V at 600 mA/cm <sup>2</sup> on H <sub>2</sub> /O <sub>2</sub> (maximum pressure of 1.5 atm) in MEA with a total loading of < 0.1 mg <sub>PGM</sub> /cm <sup>2</sup> , and less than 10% voltage degradation over 2,000 hour hold test at 600 mA/cm <sup>2</sup> at T>60 °C. Cell may be reconditioned during test to remove recoverable performance losses. (2Q, 2019)
3.7	Demonstrate MEA performance of 1,000 mW/cm <sup>2</sup> at rated power at a high-volume projected cost of \$14/kW. (1Q, 2020)
3.8	Demonstrate MEA performance of 300 mA/cm <sup>2</sup> at 0.8 V while meeting catalyst loading targets. (1Q, 2020)
3.9	Develop an MEA that can operate at maximum temperature of 120°C with a projected durability of 5,000 hours in automotive applications. (2Q, 2020)
3.10	Demonstrate long-term stable operation of metal bipolar plates with a projected cost less than or equal to \$3/kW while meeting other technical targets for corrosion (<1μA/cm <sup>2</sup> ) and resistivity (<0.01Ωcm <sup>2</sup> ). (2Q, 2020)
3.11	Demonstrate short stack with improved MEAs meeting 2020 membrane and MEA technical and cost targets. (4Q, 2020)

Task 4: Fuel Cell Performance and Durability	
4.1	Quantify Cerium migration within the membrane in microns/sec at 4 different RHs (25%, 50%, 75% and 100%) at T = 90°C under both applied potential (0.5, 1.0V) and applied current (0.5 and 1.0 A/cm <sup>2</sup> ). Propose a method to improve cerium localization by 25% during durability drive cycling. (4Q, 2016)
4.2	Develop test protocols and evaluate fuel cell components such as MEAs, bipolar plates, catalysts, membranes, etc. to determine long-term stack failure mechanisms. (3Q, 2016 thru 4Q, 2020)
4.3	Define a recovery procedure that results in > 95% recovery of known reversible degradation utilizing less than 30 sec of drive cycle time. (2Q, 2017)
4.4	Develop a cell-level performance model validated to within 10% accuracy of polarization behavior under 3 humidities at 4 temperatures. (4Q, 2017)
4.5	Demonstrate MCFC electrolyte matrix structure and chemistry in stack for >5,000 hours with 10-year life, incorporating stable supports and electrolyte management/retention techniques. (4Q, 2017)
4.6	Report on status of fuel cell system durability to meet stationary fuel cell target of greater than 60,000 hours. (4Q, 2017)
4.7	Evaluate strategies to mitigate fuel, air, and system level contaminants effect on MEA performance. (2Q, 2018)
4.8	Demonstrate less than 5 mV degradation at rated power (~1500 mA/cm <sup>2</sup> ) for any individual component over 5000 hour drive cycle with start-up/shutdown or equivalent accelerated stress test procedures. (Q4, 2019)
4.9	Demonstrate 1W/cm <sup>2</sup> rated power and current greater than 300 mA/cm <sup>2</sup> at 0.8V for an MEA with total PGM loading of or less than 0.125mg <sub>Pt</sub> /cm <sup>2</sup> . (1Q, 2020)
4.10	Demonstrate single cell performance of 5000 hours (or equivalent accelerated stress test procedures) with less than 30 mV loss at 1.5 A/cm <sup>2</sup> at total PGM loading of or less than 0.125mg <sub>Pt</sub> /cm <sup>2</sup> . (4Q, 2020)

Task 5: System BOP Components	
5.1	Develop a humidifier module with projected durability of 5,000 hours during RH cycling, and water transfer rate at 80°C of 5 grams per second. (4Q, 2019)
5.2	Develop an air compression system for 80-kW <sub>e</sub> transportation fuel cell system operating on direct hydrogen at a cost of \$500. (4Q, 2020)
5.3	Develop an air compression system for 80-kW <sub>e</sub> transportation fuel cell system operating on direct hydrogen with a combined motor and motor controller efficiency at full flow of 90%. (4Q, 2020)

Task 6: Fuel Cell Systems	
6.1	Demonstrate a fuel cell bus power plant with a durability of over 23,000 h. (2Q, 2017)
6.2	Demonstrate micro-CHP at 42.5% electrical efficiency, 87.5% CHP efficiency and projected lifetime of 40,000 hours. (2Q, 2018)
6.3	Demonstrate medium-scale CHP at 45% electrical efficiency, 87.5% CHP efficiency, and projected lifetime of 50,000 hours. (2Q, 2018)
6.4	Demonstrate micro-CHP at 45% electrical efficiency, 90% CHP efficiency and a projected lifetime of 60,000 hours. (4Q, 2020)
6.5	Demonstrate medium-scale CHP at 50% electrical efficiency, 90% CHP efficiency, and a projected lifetime of 80,000 hours, at a cost of \$2,100/kW operating on biogas. (4Q, 2020)
6.6	Demonstrate a fuel cell system for APUs with specific power of 45 W/kg, power density of 40 W/L and 40% electrical efficiency and a projected lifetime of 20,000 h. (4Q, 2020)
6.7	Develop a 65% peak-efficient, 5,000 hour durable, direct hydrogen fuel cell power system for transportation at a cost of \$40/kW (at high volumes). (4Q, 2020)
6.8	Develop a 60% efficient (over the duty cycle), direct hydrogen fuel cell power system for backup power applications at a cost of \$1,000/kW with a lifetime of 15 years, and 10,000 hours of operation. (4Q, 2020)
6.9	Develop low-cost, durable, fuel-flexible fuel processor. (4Q, 2020)

Task 7: Testing and Technical Assessments	
7.1	Test and evaluate fuel cell systems and components such as MEAs, short stacks, bipolar plates, catalysts, membranes, etc., and compare to targets. (3Q, 2016 thru 4Q, 2020)
7.2	Update fuel cell technology cost estimate for 80 kW transportation systems and compare it to targeted values. (3Q, 2016 thru 4Q, 2020)
7.3	Test and evaluate fuel cell systems and components such as MEAs, short stacks, bipolar plates, catalysts, membranes, etc. to determine long-term stack failure mechanisms. (3Q, 2016 thru 4Q, 2020)
7.4	Update fuel cell technology cost estimates for material handling, backup power units, primary power, and combined heat and power systems, and compare to target values. (2Q, 2017)
7.5	Begin fuel cell user operation for MEA cold neutron imaging utilizing lens-based imaging at 10 $\mu\text{m}$ resolution with 10 s image time. (4Q, 2017)
7.6	Begin fuel cell user operation for 1 $\mu\text{m}$ resolution neutron imaging with ~20 min. image time utilizing 10x lens. (4Q, 2018)
7.7	Perform experimental evaluation of direct hydrogen fuel cell technology at stack level for transportation applications, and compare to targets. (4Q, 2020)

## Appendix—Protocols for Testing PEM Fuel Cells and Fuel Cell Components

Testing protocols for fuel cells and fuel cell components, developed in partnership with the U.S. DRIVE Fuel Cell Technical Team, are delineated in Tables P.1 through P.11.

The electrocatalyst protocol in Table P.1 is designed to assess cathode electrocatalyst durability through the use of a voltage square wave, in which successive cycles of surface oxidation and reduction cause accelerated catalyst degradation. The protocol uses a voltage range similar to that which is expected for an automotive drive cycle, and it seeks to maximize catalyst degradation while minimizing support corrosion. The protocol was designed to test PGM-based catalysts on carbon-based supports, and it may need to be modified to test different classes of materials.

Table P.1 Electrocatalyst Cycle and Metrics		
Cycle	Square wave cycle: steps between 0.6 V (3 s) and 0.95 V (3 s) with rise time of ~0.5 s or less; run polarization curve and ECSA at specified intervals. Single cell 25–50 cm <sup>2</sup>	
Number	30,000 cycles	
Cycle time	6 s	
Temperature	80°C	
Relative humidity	Anode/cathode 100/100%	
Fuel/oxidant	H <sub>2</sub> /N <sub>2</sub> (H <sub>2</sub> at 200 sccm and N <sub>2</sub> at 75 sccm for a 50-cm <sup>2</sup> cell)	
Pressure	Atmospheric pressure	
Metric <sup>a</sup>	Frequency	Target
Catalytic mass activity <sup>b</sup>	At beginning and end of test, minimum	<40% loss of initial catalytic activity
Polarization curve from 0 to >1.5 A/cm <sup>2</sup> <sup>c</sup>	After 0, 1k, 5k, 10k, and 30k cycles	<30 mV loss at 0.8 A/cm <sup>2</sup>
ECSA/cyclic voltammetry	After 10, 100, 1k, 3k, 10k, 20k, and 30k cycles	<40% loss of initial area

<sup>a</sup> A protocol such as the one shown in Table P.9 should be used to recover reversible losses prior to measuring each metric.

<sup>b</sup> Mass activity in A/mg @ 150 kPa abs back pressure at 900 mV iR-corrected on H<sub>2</sub>/O<sub>2</sub>, 100% RH, 80°C, anode stoichiometry 2; cathode stoichiometry 9.5. A minimum hold time of 15 min is recommended, with the mass activity calculated based on the average current during the last 1 min. Multiple points should be measured at low current, and the 0.9 V iR-free potential should be determined based on these measurements. Measured ORR current may be corrected for H<sub>2</sub> crossover. Based on the protocol published by Gasteiger et al., *Applied Catalysis B: Environmental*, 56 (2005): 9–35.

<sup>c</sup> Polarization curve per protocol in Table P.6.



The catalyst support protocol in Table P.2 uses a rapid triangle wave voltage cycle to accelerate catalyst support corrosion while minimizing degradation of the catalyst itself. The potential range used in this protocol is similar to that which would occur in an unmitigated system start-up or shutdown. The protocol was designed to test PGM-based catalysts on carbon-based supports, and it may need to be modified to test different classes of materials.

Table P.2 Catalyst Support Cycle and Metrics		
Cycle	Triangle sweep cycle: 500 mV/s between 1.0 V and 1.5 V; run polarization curve and ECSA at specified intervals. Single cell 25–50 cm <sup>2</sup>	
Number	5,000 cycles	
Cycle time	2 s	
Temperature	80°C	
Relative humidity	Anode/cathode 100/100%	
Fuel/oxidant	H <sub>2</sub> /N <sub>2</sub>	
Pressure	Atmospheric	
Metric <sup>a</sup>	Frequency	Target
Catalytic activity <sup>b</sup>	At beginning and end of test, minimum	≤40% loss of initial catalytic activity
Polarization curve from 0 to ≥1.5 A/cm <sup>2</sup> <sup>c</sup>	After 0, 10, 100, 200, 500, 1k, 2k, and 5k cycles	≤30 mV loss at 1.5 A/cm <sup>2</sup> or rated power
ECSA/cyclic voltammetry	After 0, 10, 100, 200, 500, 1k, 2k, and 5k cycles	<40% loss of initial area

<sup>a</sup> A protocol such as the one shown in Table P.9 should be used to recover reversible losses prior to measuring each metric.

<sup>b</sup> Mass activity in A/mg @ 150 kPa abs back pressure at 900 mV iR-corrected on H<sub>2</sub>/O<sub>2</sub>, 100% RH, 80°C, anode stoichiometry 2; cathode stoichiometry 9.5, normalized to initial mass of catalyst and measured before and after test. Based on the protocol published by Gasteiger et al., *Applied Catalysis B: Environmental*, 56 (2005): 9–35. Measured ORR current may be corrected for H<sub>2</sub> crossover.

<sup>c</sup> Polarization curve per protocol in Table P6.

The MEA chemical stability protocol in Table P.3 uses a continuous hold at open-circuit voltage to accelerate the production of free radicals, which cause degradation of the membrane and other MEA components.

Table P.3 MEA Chemical Stability and Metrics (Test Using an MEA)		
Test condition	Steady-state OCV, single cell 25–50 cm <sup>2</sup>	
Total time	500 h	
Temperature	90°C	
Relative humidity	Anode/cathode 30/30%	
Fuel/oxidant	H <sub>2</sub> /air at stoics of 10/10 at 0.2 A/cm <sup>2</sup> equivalent flow	
Pressure, outlet kPa abs	Anode/cathode 150/150	
Metric	Frequency	Target
F <sup>-</sup> release or equivalent for nonfluorinated membranes	At least every 24 h	No target—for monitoring
Hydrogen crossover (mA/cm <sup>2</sup> ) <sup>a, b</sup>	Every 24 h	≤15 mA/cm <sup>2</sup>
OCV <sup>b, c</sup>	Continuous	Initial OCV ≥ 0.95 V, <20% OCV decrease during test
High-frequency resistance	Every 24 h at 0.2 A/cm <sup>2</sup>	No target—for monitoring
Shorting resistance <sup>d</sup>	Every 24 h	>1,000 ohm cm <sup>2</sup>

<sup>a</sup> Tested in MEA on H<sub>2</sub>, 80°C, fully humidified gases, 1 atm total pressure. See M. Inaba et. al., *Electrochimica Acta*, 51 (2006): 5746.

<sup>b</sup> Hydrogen crossover and OCV targets should be achieved at 0 kPa pressure differential and at 50 kPa anode overpressure relative to cathode, providing sensitivity to global membrane thinning and to hole formation, respectively.

<sup>c</sup> A protocol such as the one shown in Table P.9 should be used to recover reversible losses at least once every 24 h and prior to measuring each metric.

<sup>d</sup> Measured at 0.5 V applied potential, 80°C, 100% RH N<sub>2</sub>/N<sub>2</sub>. Compression to 20% strain on the GDL.

The membrane mechanical protocol in Table P.4 tests membrane durability through the use of humidity cycling, which induces repeated swelling and contraction of the membrane, accelerating the formation and growth of membrane cracks and holes.

Table P.4 Membrane Mechanical Cycle and Metrics (Test Using an MEA)		
Cycle	Cycle 0% RH (2 min) to 90°C dew point (2 min), single cell 25–50 cm <sup>2</sup>	
Total time	Until crossover >15 mA/cm <sup>2</sup> or 20,000 cycles	
Temperature	80°C	
Relative humidity	Cycle from 0% RH (2 min) to 90°C dew point (2 min)	
Fuel/oxidant	Air/air at 2 SLPM on both sides	
Pressure	Ambient or no back pressure	
Metric	Frequency	Target
Crossover <sup>a</sup>	Every 24 h	≤15 mA/cm <sup>2b</sup>
Shorting resistance <sup>c</sup>	Every 24 h	>1,000 ohm cm <sup>2</sup>

<sup>a</sup> Tested in MEA on H<sub>2</sub>, 80°C, fully humidified gases, 1 atm total pressure. See M. Inaba et. al., *Electrochimica Acta*, 51 (2006): 5746. Crossover recorded after 2 min of drying under 0% RH conditions. Hydrogen crossover target should be achieved at 0 kPa pressure differential and at 50 kPa anode overpressure, providing sensitivity to global membrane thinning and to hole formation, respectively.

<sup>b</sup> For air or N<sub>2</sub> testing, an equivalent crossover metric of 0.1 sccm/cm<sup>2</sup> at a 20 kPa pressure differential, 80°C, and 100%RH may be used as an alternative.

<sup>c</sup> Measured at 0.5 V applied potential, 80°C and 100% RH N<sub>2</sub>/N<sub>2</sub>. Compression to 20% strain on the GDL.

The chemical/mechanical protocol in Table P.5 examines the combined effects of humidity cycling and radical formation on membrane durability. Although chemical and mechanical degradation occur through different mechanisms, each mode can accelerate the other mode such that membranes that appear to have good chemical stability and good mechanical stability may fail when chemical and mechanical stresses are present concurrently.

Table P.5 Membrane Chemical/Mechanical Cycle and Metrics (Test Using an MEA)		
Cycle	Cycle 0% RH (30 s) to 90°C dew point (45 s), single cell 25–50 cm <sup>2</sup>	
Total time	Until crossover >15 mA/cm <sup>2</sup> or 20,000 cycles	
Temperature	90°C	
Relative humidity	Cycle from 0% RH (30 s) to 90°C dew point (45 s) <sup>a</sup>	
Fuel/oxidant	H <sub>2</sub> /air at 40 sccm/cm <sup>2</sup> on both sides	
Pressure	Ambient or no back pressure	
Metric	Frequency	Target
F- release or equivalent for Nonfluorine membranes	At least every 24 h	No target—for monitoring
Hydrogen crossover (mA/cm <sup>2</sup> ) <sup>b, c</sup>	Every 24 h	<15 mA/cm <sup>2</sup>
OCV <sup>c, d</sup>	Continuous	Initial wet OCV ≥ 0.95 V, <20% OCV decrease during test
High-frequency resistance	Every 24 h at 0.2 A/cm <sup>2</sup>	No target—for monitoring
Shorting resistance <sup>e</sup>	Every 24 h	>1,000 ohm cm <sup>2</sup>

<sup>a</sup> Step durations of 30 s dry and 45 s wet were selected in testing at LANL so that the HFR at the end of the dry step was 2.5 times the HFR at the end of the wet step, which is approximately equal to the HFR ratio that occurs when running the mechanical test (Table P.4). Depending on the hardware used, these step times may need to be adjusted to achieve the same HFR variation.

<sup>b</sup> Tested in MEA on H<sub>2</sub>, 80°C, fully humidified gases, 1 atm total pressure. See M. Inaba, et. al., *Electrochimica Acta*, 51 (2006): 5746. Crossover recorded after 2 min of drying under 0% RH conditions.

<sup>c</sup> Hydrogen crossover and OCV targets should be achieved at 0 kPa pressure differential and at 50 kPa anode overpressure, providing sensitivity to global membrane thinning and to hole formation, respectively.

<sup>d</sup> A protocol such as the one shown in Table P.9 should be used to recover reversible losses at least once every 24 h and prior to measuring each metric.

<sup>e</sup> Measured at 0.5 V applied potential, 80°C, 100% RH N<sub>2</sub>/N<sub>2</sub>. Compression to 20% strain on the GDL.

The polarization protocol in Table P.6 provides a standardized way to test MEA performance in different operating regimes, and it should be used as specified in the target tables to assess progress toward performance and durability targets.

Table P.6 Polarization Protocol <sup>a</sup>						
Test Point #	Current Density (A/cm <sup>2</sup> )	Anode H <sub>2</sub> Stoich.	Cathode Inlet O <sub>2</sub> % (Dry Basis)	Cathode Inlet N <sub>2</sub> % (Dry Basis)	Cathode O <sub>2</sub> Stoich.	Test Point Run Time (min)
<b>Break-In</b>						
B1	0.6	1.5	21%	79%	1.8	20
<b>Reduction</b>						
R1	0	1.5	21%	79%	1.8	1
R2	0	1.5	0%	100%	1.8	Until V<0.1V
<b>Polarization Curve</b>						
P1	0.2	1.5	21%	79%	1.8	3
P2	0.4	1.5	21%	79%	1.8	3
P3	0.6	1.5	21%	79%	1.8	3
P4	0.8	1.5	21%	79%	1.8	3
P5	1	1.5	21%	79%	1.8	3
P6	1.2	1.5	21%	79%	1.8	3
P7	1.4	1.5	21%	79%	1.8	3
P7	1.6	1.5	21%	79%	1.8	3
P8	1.8	1.5	21%	79%	1.8	3
P9	2	1.5	21%	79%	1.8	3
P10	1.8	1.5	21%	79%	1.8	3
P11	1.6	1.5	21%	79%	1.8	3
P12	1.4	1.5	21%	79%	1.8	3
P13	1.2	1.5	21%	79%	1.8	3

Table P.6 Polarization Protocol <sup>a</sup>						
Test Point #	Current Density (A/cm <sup>2</sup> )	Anode H <sub>2</sub> Stoich.	Cathode Inlet O <sub>2</sub> % (Dry Basis)	Cathode Inlet N <sub>2</sub> % (Dry Basis)	Cathode O <sub>2</sub> Stoich.	Test Point Run Time (min)
P14	1	1.5	21%	79%	1.8	3
P15	0.8	1.5	21%	79%	1.8	3
P16	0.6	1.5	21%	79%	1.8	3
P17	0.4	1.5	21%	79%	1.8	3
P18	0.2	1.5	21%	79%	1.8	3
P19	0.1	1.5	21%	79%	1.8	3
P20	0.05	1.5	21%	79%	1.8	3
P21	0.02	1.5	21%	79%	1.8	3
P22	0.05	1.5	21%	79%	1.8	3
P23	0.1	1.5	21%	79%	1.8	3
P24	0.2	1.5	21%	79%	1.8	3

<sup>a</sup> The following parameters are constant throughout the test: anode inlet composition of 100% H<sub>2</sub> (excluding water vapor) at 80°C, humidified to 59°C dew point, 150 kPa<sub>abs</sub> outlet pressure; cathode feed at 80°C, humidified to 59°C dew point, 150 kPa<sub>abs</sub> outlet pressure; cell/stack control temperature of 80°C; set-point transition time of 0 s. The anode and cathode flow rate stoichiometric ratios are 1.5 and 1.8, respectively, for currents of 0.2 A/cm<sup>2</sup> or greater, with 0.2 A/cm<sup>2</sup> equivalent flows used at lower currents (affected points highlighted in gray).

The drive-cycle protocol in Table P.7 should be used as specified in the target tables to test system, stack, and MEA lifetime. The protocol incorporates operating conditions that are expected to occur during typical operation of a fuel cell vehicle, but it excludes conditions associated with unmitigated start-ups and shutdowns, freeze operation, fuel starvation, and system fault conditions.

Table P.7 Drive-Cycle Durability Protocol <sup>a, b, c</sup>									
Test Point #	Current Density (A/cm <sup>2</sup> )	Anode H <sub>2</sub> Stoich.	Anode Dew Point Temp. (°C)	Anode Inlet Temp. (°C)	Cathode O <sub>2</sub> Stoich.	Cathode Dew Point Temp. (°C)	Cathode Inlet Temp. (°C)	Test Point Run Time (min)	Worst-Case Response Transition Time (s)
<b>Wet with Load Cycling</b>									
RH1	0.02	96	83°	85°	108	83°	85°	0.5	2
RH2	1.2	1.6	83°	85°	1.8	83°	85°	0.5	2
RH3	0.02	96	83°	85°	108	83°	85°	0.5	2
RH4	1.2	1.6	83°	85°	1.8	83°	85°	0.5	2
RH5	0.02	96	83°	85°	108	83°	85°	0.5	2
RH6	1.2	1.6	83°	85°	1.8	83°	85°	0.5	2
RH7	0.02	96	83°	85°	108	83°	85°	0.5	2
RH8	1.2	1.6	83°	85°	1.8	83°	85°	0.5	2
RH9	0.02	96	83°	85°	108	83°	85°	0.5	2
RH10	1.2	1.6	83°	85°	1.8	83°	85°	0.5	2
Trans1	0.6	2	70°	80°	2	70°	80°	2	30 (dew point)
<b>Dry with Load Cycling</b>									
RH11	0.1	5	53°	80°	5	53°	80°	0.5	30 (dew point)
RH12	0.02	25	53°	80°	25	53°	80°	0.5	2
RH13	0.1	5	53°	80°	5	53°	80°	0.5	2
RH14	0.02	25	53°	80°	25	53°	80°	0.5	2
RH15	0.1	5	53°	80°	5	53°	80°	0.5	2
RH16	0.02	25	53°	80°	25	53°	80°	0.5	2
RH17	0.1	5	53°	80°	5	53°	80°	0.5	2
RH18	0.02	25	53°	80°	25	53°	80°	0.5	2



Table P.7 Drive-Cycle Durability Protocol <sup>a, b, c</sup>									
RH19	0.1	5	53°	80°	5	53°	80°	0.5	2
RH20	0.02	25	53°	80°	25	53°	80°	5 <sup>d</sup>	2

<sup>a</sup> The following parameters are constant throughout the test: anode inlet composition of 80% H<sub>2</sub>/20% N<sub>2</sub> (excluding water vapor), cathode inlet composition of 21% O<sub>2</sub>/79% N<sub>2</sub> (excluding water vapor), anode and cathode outlet pressures of 101.3 kPa<sub>abs</sub>, cell/stack control temperature of 80°C, and set-point transition time of 0 s.

<sup>b</sup> Drive-cycle testing reflects only degradation losses associated with wet and dry cyclic operation. Other relevant stressors, including start-up/shutdown and freeze operation, are not included in this test.

<sup>c</sup> A protocol such as the one shown in Table P.9 should be used to recover reversible losses at least once every 24 h.

<sup>d</sup> The 5-min hold in step RH20 is intended to represent a system idle point.

The start-up/shutdown protocol in Table P.8 involves the passage of a hydrogen/air front, similar to the front that is expected during unmitigated start-ups and shutdowns of a fuel cell system. This front can cause rapid degradation of catalyst supports and other cell components through large potential swings, local combustion, and radical formation.

Table P.8 Unmitigated Start-Up/Shutdown Durability Protocol								
Total time	5,000 cycles will take ~10 d, with 500 cycles/d (~19.5 h) and up to 5.5 h for characterization							
Temperature	35°C							
Pressure	101.3 kPa							
Characterization	Polarization curve, ECSA, and impedance spectra should be measured at 80°C, 100% RH. Characterization should be repeated approximately every 24 h (~500 cycles).							
Step	Step Name	Duration (s)	Voltage (V)	Current (A/cm <sup>2</sup> )	Load	Anode Gas <sup>a</sup>	Anode Stoich.	RH
1	FC Operation	60 <sup>b</sup>		0.4	On	H <sub>2</sub>	1.2	100
2	Pre-shutdown	10	1		On	H <sub>2</sub>	0	100
3	Shutdown	5			Off	Air	Varies <sup>c</sup>	0
4	Idle	55			Off	Air	1 (at 0.1 A/cm <sup>2</sup> )	0
5	Start-up	10	1		On	H <sub>2</sub>	1.2 (at 1.0 A/cm <sup>2</sup> )	100
Metric		Target			Guideline			
Voltage at 1.2 A/cm <sup>2</sup>	<5% change		Voltage at 1.2 A/cm <sup>2</sup>	<5% change		Voltage at 1.2 A/cm <sup>2</sup>	<5% change	
ECSA		<20% change	ECSA		<20% change	ECSA		<20% change
HFR at 0.02 and 1.2 A/cm <sup>2</sup>		<5% change	HFR at 0.02 and 1.2 A/cm <sup>2</sup>		<5% change	HFR at 0.02 and 1.2 A/cm <sup>2</sup>		<5% change
LFR at 0.02 and 1.2 A/cm <sup>2</sup>		<10% change	LFR at 0.02 and 1.2 A/cm <sup>2</sup>		<10% change	LFR at 0.02 and 1.2 A/cm <sup>2</sup>		<10% change

<sup>a</sup> Anode gas is H<sub>2</sub> or air, depending on step. Cathode gas should be air at a flow rate corresponding to a stoich. of 2 at 1.0 A/cm<sup>2</sup> current for all steps.

<sup>b</sup> Attain steady-state operation before moving to Step 2.

<sup>c</sup> Anode flow rate must be defined by specific cell architecture, and it should correspond to an average residence time of 0.3 s. Cell voltage should decrease to < 0.1 V within 1 s (~3 volumetric exchanges).

Various degradation mechanisms are expected to occur during fuel cell testing, including both reversible and irreversible mechanisms. The MEA recovery protocol in Table P.9 should be used as specified in the target tables to recover the reversible losses prior to performance testing.

Step	Step Name	Anode Comp.	Anode Flow (SLPM)	Cathode Comp.	Cathode Flow (SLPM)	Duration (s)
1	N <sub>2</sub> soak	100% N <sub>2</sub>	2	100% N <sub>2</sub>	4	120
2	Air soak	N/A	0	Air	4	900
3	N <sub>2</sub> soak	100% N <sub>2</sub>	2	100% N <sub>2</sub>	4	120
4	H <sub>2</sub> soak	100% H <sub>2</sub>	2	N/A	0	600
5	H <sub>2</sub> -air back on	100% H <sub>2</sub>	2	Air	4	5

<sup>a</sup> The following parameters are constant throughout the test: anode and cathode inlet RH = 100%, anode and cathode outlet pressure = 150 kPa abs. Cell temperature should be set to the temperature of the upcoming diagnostic test.

Air compressors for automotive fuel cell systems should be able to perform all the tests in the protocol in Table P.10 without significant wear or breakage. The compressor should remain capable of meeting all performance targets following completion of the tests in this protocol.

This protocol represents a limited set of tests for basic screening and durability testing. It is not a complete set of durability tests that a fully engineered product would be expected to meet.

Table P.10 Air Compressor Durability Protocol	
Test	Test Conditions
Start-stop	<ul style="list-style-type: none"> <li>• Reflects both key-on and capability for fuel cell stop-start during operation</li> <li>• Performed at 25°C, with coolant at 60–70°C</li> <li>• 200,000 cycles from 0 RPM to idle speed</li> <li>• 50,000 power on/off reflecting key on/off</li> <li>• 150,000 with compressor powered reflecting system idle</li> </ul>
Freeze start	<ul style="list-style-type: none"> <li>• Performed at -30°C</li> <li>• 1,000 cycles from 0 RPM to idle speed</li> <li>• Coolant quenching may be used to enable faster cycling</li> </ul>
Cycling	<ul style="list-style-type: none"> <li>• Reflects normal drive transients</li> <li>• 150,000 cycles between maximum speed and 25% of maximum speed</li> <li>• Cycling performed at maximum acceleration/deceleration rates</li> </ul>
High load	<ul style="list-style-type: none"> <li>• Inlet T = 40°C</li> <li>• Run at maximum flow rate and pressure for 300 h</li> </ul>

Humidifiers for automotive fuel cell systems should be able to perform all the tests in the protocol in Table P.11 without significant wear or breakage. The leak rate following the completion of each test in the protocol should be less than 15 SLPM (based on dry air, with 50 kPa g on the dry side and ambient pressure on the wet side). Any reduction in the water transport rate should represent less than a 10% loss of the BOL transport rate.

This protocol represents a limited set of tests for basic screening and durability testing. It is not a complete set of durability tests that a fully engineered product would be expected to meet.

“Full flow conditions” refers to Dry air in: 3,000 SLPM dry gas flow, 183 kPa abs, 80°C, and 0% RH. Wet air in: 2,600 SLPM dry gas flow, 160 kPa abs, 80°C, and 85% RH.

Table P.11 Humidifier Durability Protocol	
Test	Test Conditions
High load	<ul style="list-style-type: none"> <li>Run at full flow rate for 300 h</li> </ul>
Humidity cycling	<ul style="list-style-type: none"> <li>Same test as cell membrane mechanical cycle (Table P.4): 80°C, ambient pressure                             <ul style="list-style-type: none"> <li>Cycle from 0% RH (2 min) to 90°C dew point (2 min)</li> <li>Use full flow conditions, except dew point as above</li> </ul> </li> <li>Perform 20,000 cycles, with leakage rate checked every 24 hrs</li> </ul>
Pressure cycling	<ul style="list-style-type: none"> <li>Cycle dry-side pressure from 0 kPa g to 75 kPa g, 20,000 cycles, 3 s high/3 s low pressure</li> <li>Wet side maintained at ambient pressure (no flow)</li> </ul>